

# Keysight Technologies

## E8257D PSG

### Microwave Analog Signal Generator

Data Sheet

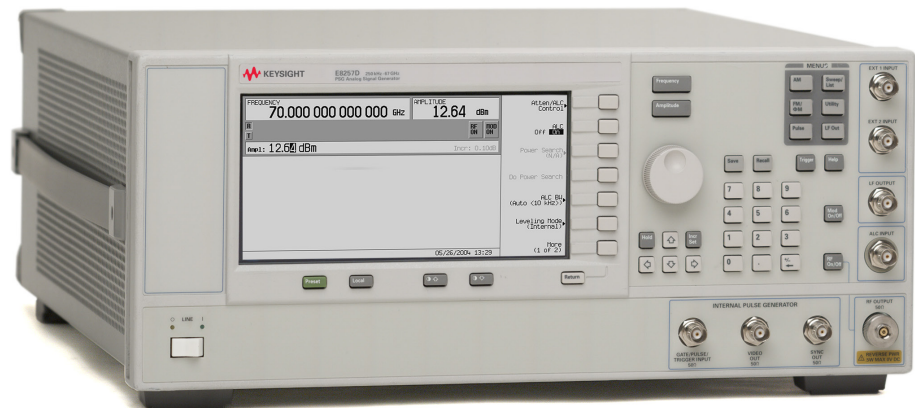

## Table of Contents

<b>Specifications</b> .....	4
Frequency .....	4
Step (digital) sweep .....	5
Ramp (analog) sweep .....	6
Output .....	7
Spectral purity .....	13
Frequency modulation .....	23
Phase modulation .....	24
Amplitude modulation .....	26
External modulation inputs .....	27
Internal modulation source .....	27
Pulse modulation .....	28
Internal pulse generator .....	30
Simultaneous modulation .....	30
Remote programming .....	31
General specifications .....	32
<b>Input/Output Descriptions</b> .....	33
Front panel connectors .....	33
Rear panel connectors .....	34
<b>Options, Accessories, and Related Products</b> .....	35
<b>Related Keysight Literature</b> .....	36
<b>Web Resources</b> .....	36



## Introduction

The Keysight E8257D is a fully-synthesized signal generator with high output power, low phase noise, and modulation capability.

Specifications apply over a 0 to 55 °C range, unless otherwise stated, and apply after a 45 minute warm-up time. Supplemental characteristics, denoted as typical, nominal, or measured, provide additional (non-warranted) information at 25 °C, which may be useful in the application of the product.

Unless otherwise noted, this data sheet applies to units with serial numbers ending with 50420000 or greater.

## Definitions

**Specifications (spec):** Represents warranted performance for instruments with a current calibration.

**Typical (typ):** Represents characteristic performance which is non-warranted. Describes performance that will be met by a minimum of 80% of all products.

**Nominal (nom):** Represents characteristic performance which is non-warranted. Represents the value of a parameter that is most likely to occur; the expected mean or mode of all instruments at room temperature (approximately 25 °C).

**Measured:** Represents characteristic performance which is non-warranted. Represents the value of a parameter measured on an instrument during design verification.

## Specifications

Frequency			
Range	Specified range	Tunable range	
Option 513	250 kHz to 13 GHz	100 kHz to 13 GHz	
Option 520	250 kHz to 20 GHz	100 kHz to 20 GHz	
Option 521 <sup>1</sup>	10 MHz to 20 GHz	10 MHz to 20 GHz	
Option 532	250 kHz to 31.8 GHz	100 kHz to 31.8 GHz	
Option 540	250 kHz to 40 GHz	100 kHz to 40 GHz	
Option 550	250 kHz to 50 GHz	100 kHz to 50 GHz	
Option 567	250 kHz to 67 GHz	100 kHz to 70 GHz	
Resolution			
CW	0.001 Hz		
All sweep modes <sup>2</sup>	0.01 Hz		
CW switching speed <sup>3,4,5</sup>	Standard	Opt UNX	Opt UNY
	< 11 ms (typ)	< 11 ms (typ)	< 26 ms (typ)
	< 7 ms (nom)	< 7 ms (nom)	< 22 ms (nom)
Phase offset	Adjustable in nominal 0.1 ° increments		
Frequency bands	Frequency range	N <sup>6</sup>	
1	250 kHz to 250 MHz	1/8	
2	> 250 to 500 MHz	1/16	
3	> 500 MHz to 1 GHz	1/8	
4	> 1 to 2 GHz	1/4	
5	> 2 to 3.2 GHz	1/2	
6	> 3.2 to 10 GHz	1	
7	> 10 to 20 GHz	2	
8	> 20 to 40 GHz	4	
9	> 40 GHz	8	
Accuracy	± [(time since last adjustment x aging rate) + temperature effects + line voltage effects + calibration accuracy]		
Internal timebase reference oscillator (OCXO)			
Aging rate <sup>7</sup>	< ± 3 x 10 <sup>-8</sup> /year or < ± 2.5 x 10 <sup>-10</sup> /day after 30 days		
Initial achievable calibration accuracy	< ± 4 x 10 <sup>-8</sup>		
Temperature effects (typ)	< ± 4.5 x 10 <sup>-9</sup> from 0 to 55 °C		
Line voltage effects (typ)	< ± 2 x 10 <sup>-10</sup> for ± 10% change		

- For Option 521, performance is degraded below 500 MHz. Refer to specifications for more detail.
- In ramp sweep mode (Option 007), resolution is limited with narrow spans and slow sweep speeds. Refer to ramp sweep specifications for more information.
- Time from GPIB trigger to frequency within 0.1 ppm of final frequency above 250 MHz or within 100 Hz below 250 MHz. CW switching speed to within 0.05% of final frequency is ≥ 5 ms (nom).
- Add 12 ms (typical) when switching from greater than 3.2 GHz to less than 3.2 GHz. Option HY2 switching speed is 30 ms (nom) for 250 kHz to 3.2 GHz and 40 ms (nom) for > 3.2 GHz.
- With Option 1EH low band harmonic filters off. With the 1EH filters turned on, add 4 ms.
- N is a factor used to help define certain specifications within the document.
- Not verified by Keysight N7800A TME Calibration and Adjustment Software. Daily aging rate may be verified as a supplementary chargeable service, on request.

## Specifications (continued)

<b>External reference</b>			
Frequency	10 MHz only		
Lock range	$\pm 1.0$ ppm		
<b>Reference output</b>			
Frequency	10 MHz		
Amplitude	> +4 dBm into 50 $\Omega$ load (typ)		
<b>External reference input</b>			
Amplitude	5 dBm $\pm$ 5 dB <sup>1</sup>		
Input impedance	50 $\Omega$ (nom)		
<b>Step (digital) sweep</b>			
<b>Operating modes</b>			
	Step sweep of frequency or amplitude or both (start to stop)		
	List sweep of frequency or amplitude or both (arbitrary list)		
<b>Sweep range</b>			
Frequency sweep	Within instrument frequency range		
Amplitude sweep	Within attenuator hold range (see "Output" section)		
<b>Dwell time</b>			
	1 ms to 60 s		
<b>Number of points</b>			
Step sweep	2 to 65535		
List sweep	2 to 1601 per table		
<b>Triggering</b>			
	Auto, external, single, or GPIB		
<b>Settling time</b>			
	<b>Standard</b>	<b>Opt UNX</b>	<b>Opt UNY</b>
Frequency <sup>2</sup>	< 9 ms (typ)	< 9 ms (typ)	< 24 ms (typ)
Amplitude	< 5 ms (typ)	< 5 ms (typ)	< 5 ms (typ)

1. To optimize phase noise use 5 dBm  $\pm$  2 dB.

2. 19 ms (typ) when stepping from greater than 3.2 GHz to less than 3.2 GHz. Option HY2 switching speed is 30 ms (nom) for 250 kHz to 3.2 GHz and 40 ms (nom) for > 3.2 GHz.

## Specifications (continued)

<b>Ramp (analog) sweep (Option 007) <sup>1</sup></b>			
<b>Operating modes</b>			
<ul style="list-style-type: none"> <li>- Synthesized frequency sweep (start/stop), (center/span), (swept CW)</li> <li>- Power (amplitude) sweep (start/stop)</li> <li>- Manual sweep               <ul style="list-style-type: none"> <li>- RPG control between start and stop frequencies</li> </ul> </li> <li>- Alternate sweep               <ul style="list-style-type: none"> <li>- Alternates successive sweeps between current and stored states</li> </ul> </li> </ul>			
<b>Sweep span range</b>	Settable from minimum <sup>2</sup> to full range		
<b>Maximum sweep rate</b>	<b>Start frequency</b>	<b>Maximum sweep rate</b>	<b>Max span for 100 ms sweep</b>
	250 kHz to < 0.5 GHz	25 MHz/ms	2.5 GHz
	0.5 to < 1 GHz	50 MHz/ms	5 GHz
	1 to < 2 GHz	100 MHz/ms	10 GHz
	2 to < 3.2 GHz	200 MHz/ms	20 GHz
	≥ 3.2 GHz	400 MHz/ms	40 GHz
<b>Frequency accuracy</b>	± 0.05% of span ± timebase (at 100 ms sweep time, for sweep spans less than maximum values given above). Accuracy improves proportionally as sweep time increases <sup>3</sup>		
<b>Sweep time (forward sweep, not including bandswitch and retrace intervals)</b>			
Manual mode	Settable 10 ms to 200 seconds		
Resolution	1 ms		
Auto mode	Set to minimum value determined by maximum sweep rate and 8757D setting		
<b>Triggering</b>	Auto, external, single, or GPIB		
<b>Markers</b>	10 independent continuously variable frequency markers		
Display	Z-axis intensity or RF amplitude pulse		
Functions	M1 to center, M1/M2 to start/stop, marker delta		
<b>Two-tone (master/slave) measurements <sup>4</sup></b>	Two PSGs can synchronously track each other, with independent control of start/stop frequencies		
<b>Network analyzer compatibility</b>	Compatible with Keysight 8757D scalar network analyzer. Also useable with Keysight 8757A/C/E scalar network analyzers for making basic swept measurements. <sup>5</sup>		

1. During ramp sweep operation, AM, FM, phase modulation, and pulse modulation are usable but performance is not guaranteed.
2. Minimum settable sweep span is proportional to carrier frequency and sweep time. Actual sweep span may be slightly different than desired setting for spans less than  $[0.00004\% \text{ of carrier frequency or } 140 \text{ Hz}] \times [\text{sweep time in seconds}]$ . Actual span will always be displayed correctly.
3. Typical accuracy for sweep times > 100 ms can be calculated from the equation:  $[(0.005\% \text{ of span})/(\text{sweep time in seconds})] \pm \text{timebase}$ . Accuracy is not specified for sweep times < 100 ms.
4. For master/slave operation use Keysight part number 8120-8806 master/slave interface cable.
5. GPIB system interface is not supported with 8757A/C/E, only with 8757D. As a result, some features of 8757A/C/E, such as frequency display, pass-through mode, and alternate sweep, do not function with PSG signal generators.

## Specifications (continued)

Output					
Minimum settable output power					
Standard	-20 dBm				
With Option 1E1 step attenuator					
Options 513, 520, 521, 532, and 540	-135 dBm				
Options 550 and 567	-110 dBm				
Maximum output power (dBm) <sup>1</sup>			Spec (Typ)		
Frequency range <sup>2</sup>	Standard	Option 1EU	Option 1E1	Options 1E1 + 1EU	Option HY2 <sup>3</sup>
Options 513 and 520					
Low phase noise mode on					
10 to 250 MHz (filters on)	+11	+11 (+13)	+11	+11 (+13)	
1 to 250 MHz (filters off) <sup>4</sup>	+15	+16 (+17)	+15	+16 (+17)	
Low phase noise mode off					
10 to 250 MHz (filters on)	+15	+15 (+17)	+15	+15 (+17)	
> 0.25 to 2 GHz (filters on)	+15	+16 (+17)	+15	+16 (+17)	
250 kHz to 10 MHz	+14	+14 (+17)	+14	+14 (+17)	
> 10 to < 60 MHz	+15	+16 (+19)	+15	+16 (+19)	
60 to 400 MHz	+15	+20 (+21)	+15	+20 (+21)	
> 0.4 to 3.2 GHz <sup>5</sup>	+15	+21 (+23)	+15	+21 (+23)	
> 3.2 to 10 GHz	+15	+22 (+23)	+14	+21 (+22)	
> 10 to 20 GHz	+15	+21 (+23)	+14	+19 (+21)	
Option HY2 carrier frequency <sup>6</sup>					
250 kHz to < 1 MHz					+14 (+17)
1 MHz to < 10 MHz					+16 (+17)
10 to 250 MHz					+11 (+13)
> 0.25 to 2 GHz					+16 (+17)
> 2 to 3.2 GHz					+21 (+23)
> 3.2 to 10 GHz					+21 (+22)
> 10 GHz to 20 GHz					+19 (+21)
Option 521 <sup>7</sup>					
Low phase noise mode on					
10 to 250 MHz (filters on)	+11 (+13)	n/a	+11 (+13)	n/a	
10 to 250 MHz (filters off) <sup>4</sup>	+16 (+17)	n/a	+16 (+17)	n/a	
Low phase noise mode off					
10 to 250 MHz (filters on)	+16 (+18)	n/a	+16 (+18)	n/a	
> 0.25 to 2 GHz (filters on)	+18 (+20)	n/a	+18 (+20)	n/a	
10 to 250 MHz	+19 (+21)	n/a	+19 (+21)	n/a	
> 0.25 to 1 GHz	+24 (+26)	n/a	+24 (+26)	n/a	
> 1 to 6 GHz <sup>5</sup>	+28 (+30)	n/a	+28 (+30)	n/a	
> 6 to 14 GHz	+28 (+30)	n/a	+27 (+28)	n/a	
> 14 to 17.5 GHz	+26 (+28)	n/a	+25 (+27)	n/a	
> 17.5 to 20 GHz	+24 (+27)	n/a	+23 (+26)	n/a	

- Maximum power specifications are warranted from 15 to 35 °C, and are typical from 0 to 15 °C. Maximum power over the 35 to 55 °C range typically degrades less than 2 dB.
- With Option 1EH low-pass filters below 2 GHz switched off, unless otherwise specified.
- Option HY2 requires ordering Option 1E1 +1EH +1EU. Maximum power specifications are warranted from 15 to 35 °C and are typical from 0 to 15 °C. Maximum operating temperature of Option HY2 is 35 °C.
- In this mode, harmonics are large and output power refers to the total power including harmonics.
- With Option 1EH low-pass filters below 2 GHz switched off. With filters on, this specification applies above 2 GHz.
- With Option HY2 operating in SNR mode.
- Option 521 includes low-pass filters below 2 GHz as standard.

## Specifications (continued)

Option 532 and 540				
Low phase noise mode on				
10 to 250 MHz (filters on)	+10	+10 (+12)	+10	+10 (+12)
1 to 250 MHz (filters off) <sup>1</sup>	+11	+15 (+16)	+11	+15 (+16)
Low phase noise mode off				
10 to 250 MHz (filters on)	+11	+14 (+16)	+11	+14 (+16)
> 0.25 to 2 GHz (filters on)	+11	+15 (+16)	+11	+15 (+16)
250 kHz to 10 MHz	+11	+13 (+16)	+11	+13 (+16)
> 10 to < 60 MHz	+11	+15 (+18)	+11	+15 (+18)
60 to 400 MHz	+11	+19 (+21)	+11	+19 (+21)
> 0.4 to 3.2 GHz <sup>2</sup>	+11	+20 (+22)	+11	+20 (+22)
> 3.2 to 17 GHz	+11	+19 (+21)	+10	+17 (+20)
> 17 to 37 GHz	+11	+16 (+19)	+9	+14 (+17)
> 37 to 40 GHz	+11	+14 (+17)	+9	+12 (+16)
Option 550 and 567				
Low phase noise mode on				
10 to 250 MHz (filters on)	+5	+9 (+11)	+5	+9 (+11)
1 to 250 MHz (filters off) <sup>1</sup>	+5	+14 (+16)	+5	+14 (+16)
Low phase noise mode off				
10 to 250 MHz (filters on)	+5	+13 (+15)	+5	+13 (+15)
> 0.25 to 2 GHz (filters on)	+5	+14 (+15)	+5	+14 (+15)
250 kHz to 10 MHz	+5	+12 (+15)	+5	+12 (+15)
> 10 to < 60 MHz	+5	+14 (+17)	+5	+14 (+17)
60 to 400 MHz	+5	+18 (+20)	+5	+18 (+20)
> 0.4 to 3.2 GHz <sup>2</sup>	+5	+19 (+21)	+5	+19 (+21)
> 3.2 to 15 GHz	+5	+18 (+21)	+4	+17 (+20)
> 15 to 30 GHz	+5	+14 (+16)	+3	+13 (+15)
> 30 to 65 GHz	+5	+11 (+14)	+3	+9 (+12)
> 65 to 67 GHz	+5	+10 (+14)	+3	+8 (+12)
> 67 to 70 GHz	(+5)	(+8)	(+3)	(+6)

1. In this mode, harmonics are large and output power refers to the total power including harmonics.

2. With Option 1EH low-pass filters below 2 GHz switched off. With filters on, this specification applies above 2 GHz.



## Specifications (continued)

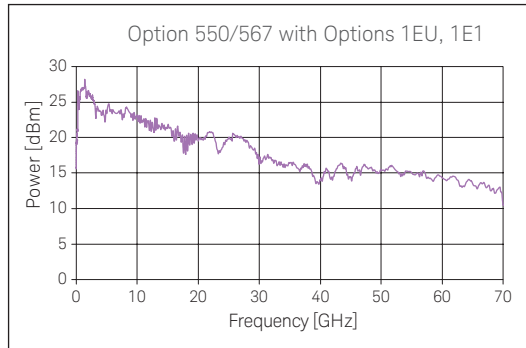
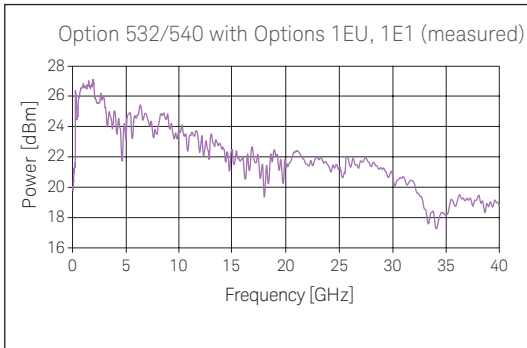
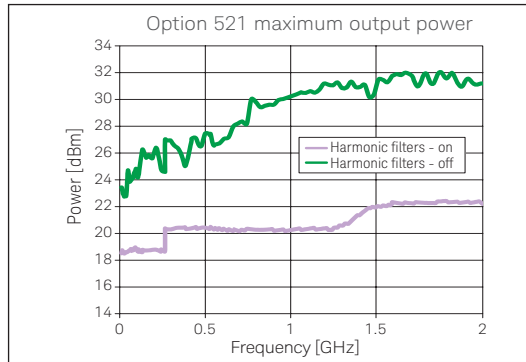
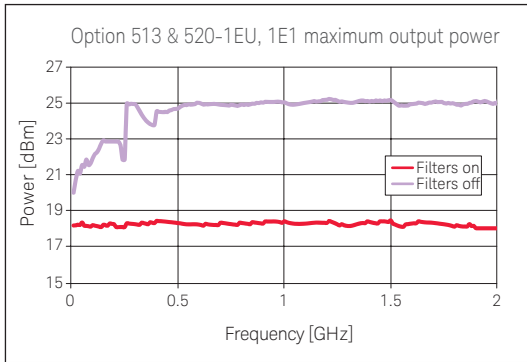
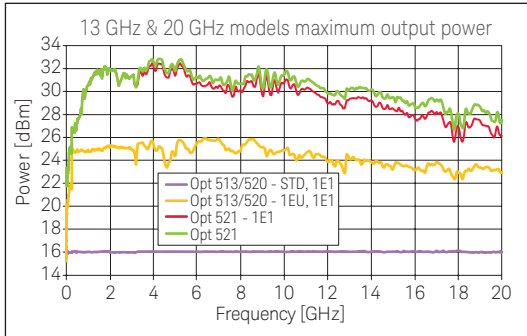

Maximum output power (measured)

### Step attenuator (Option 1E1) <sup>1</sup>

Options 513, 520, 521, 532, and 540      0 dB and 5 dB to 115 dB in 10 dB steps

With Optimize S/N on <sup>2</sup>      0 dB to 115 dB in 5 dB steps

Options 550 and 567      0 dB to 90 dB in 10 dB steps

### Attenuator hold range

Minimum      From -20 dBm to maximum specified output power with step attenuator in 0 dB position.  
Can be offset using Option 1E1 attenuator.

1. The step attenuator provides coarse power attenuation to achieve low power levels. Fine power level adjustment is provided by the ALC (automatic level control) within the attenuator hold range.
2. With attenuator in auto mode. Optimize S/N mode provides improved signal/noise performance and is included with Option 521 and Option 1EU models. Specs in the following sections (such as level accuracy, spectral purity, modulation, etc) are only tested with Optimize S/N mode turned off.

## Specifications (continued)

Amplitude switching speed							
ALC on	< 6 ms (typ) <sup>1</sup>						
ALC off	< 10 ms (typ) (not including power search) <sup>2</sup>						
Level accuracy <sup>3</sup> (dB)	> 20 dBm	20 to > 16 dBm	16 to > 10 dBm	10 to > 0 dBm	0 to -10 dBm	< -10 to -20 dBm	
Options 513, 520, 532, 540, 550, 567							
250 kHz to 2 GHz <sup>4,5</sup>	± 0.8	± 0.8 <sup>6</sup>	± 0.6	± 0.6	± 0.6	± 1.2	
> 2 to 20 GHz	± 1.0	± 0.8	± 0.8	± 0.8	± 0.8	± 1.2	
> 20 to 40 GHz		± 1.0	± 1.0	± 0.9	± 0.9	± 1.3	
> 40 to 50 GHz				± 1.3	± 0.9	± 1.2	
> 50 to 67 GHz				± 1.5	± 1.0	± 1.2 (typ)	
Option 521							
10 to < 500 MHz <sup>4,7</sup>	± 1.9 (typ)	± 1.2 (typ)	± 1.2 (typ)	± 1.1 (typ)	± 1.2 (typ)	± 1.2 (typ)	
0.5 to 20 GHz	± 1.0 <sup>8</sup>	± 0.8	± 0.8	± 0.8	± 0.9	± 1.1 <sup>9</sup>	
Level accuracy with step attenuator (Option 1E1) <sup>10</sup> (dB)							
	26 to > 20 dBm	20 to > 16 dBm	16 to > 10 dBm	10 to > 0 dBm	0 to -10 dBm	< -10 to -70 dBm	< -70 to -90 dBm
Options 513, 520, 53, 540, 550, 567							
250 kHz to 2 GHz <sup>4,5</sup>	± 1.0	± 0.8 <sup>6</sup>	± 0.6	± 0.6	± 0.6	± 0.7	± 0.8
> 2 to 20 GHz	± 1.0	± 0.8	± 0.8	± 0.8	± 0.8	± 0.9	± 1.0
> 20 to 40 GHz	–	± 1.0	± 1.0	± 0.9	± 0.9	± 1.0	± 2.0
> 40 to 50 GHz	–	–	–	± 1.3	± 0.9	± 1.5	± 2.5
> 50 to 67 GHz	–	–	–	± 1.5	± 1.0	± 1.5 (typ)	± 2.5 (typ)
Option 521							
10 to < 500 MHz <sup>4,11</sup>		± 1.3	± 0.8	± 0.8	± 0.7	± 1.0	± 1.0
0.5 to 20 GHz	± 1.0 <sup>8</sup>	± 0.8	± 0.8	± 0.8	± 0.8	± 1.1	± 1.1

- To within 0.1 dB of final amplitude within one attenuator range. Does not apply to Option 521 below 500 MHz.
- To within 0.5 dB of final amplitude within one attenuator range. Also applies to Option 521 below 500 MHz with ALC on. Add up to 50 ms when using power search.
- Specifications apply in CW and list/step sweep modes over the 15 to 35 °C temperature range with the ALC on. Degradation outside this temperature range, for power levels > -10 dBm is typically < 0.3 dB (except < 0.5 dB from 2 to 3.2 GHz and with Option 521 below 500 MHz). In ramp sweep mode (with Option 007), specifications are typical. For instruments with Type-N connectors (Option 1ED), specifications are degraded typically 0.2 dB above 18 GHz.
- When Option UNX or UNY low phase noise mode is on, specifications below 250 MHz apply only when Option 1EH low-pass filters below 2 GHz are on. With Option 1EH low-pass filters below 2 GHz off, accuracy is typically ± 2 dB.
- For Option 550 and 567, degrade level accuracy by 0.2 dB from 1.7 to 2 GHz when step attenuator is set to 0 dB or when Option 1E1 is not present.
- Nominal above +16 dBm from 10 MHz to 60 MHz.
- With Option 521, specifications below 500 MHz are typical, and apply for a 50 Ω load with VSWR less than 1.4:1.
- Typical above +26 dBm.
- Typical below -15 dBm.
- Specifications apply in CW and list/step sweep modes over the 15 to 35 °C temperature range, with the ALC on and attenuator hold off (normal operating mode). Degradation outside this temperature range, with attenuator hold on and ALC power levels > -10 dBm, is typically < 0.3 dB (except < 0.5 dB from 2 to 3.2 GHz and with Option 521 below 500 MHz). In ramp sweep mode (with Option 007), specifications are typical. For instruments with type-N connectors (Option 1ED), specifications apply to 18 GHz only. From 18 to 20 GHz, typical level accuracy degrades by 0.2 dB. Specifications do not apply above the maximum specified power.
- With Option 521, specifications below 500 MHz apply with step attenuator set to 5 dB or higher (requiring Attenuator Hold ON above 8 dBm). With step attenuator set to 0 dB, refer to level accuracy specifications without Option 1E1.

## Specifications (continued)

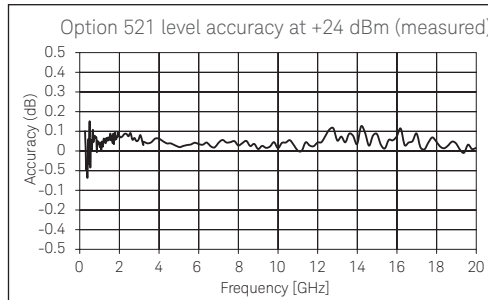
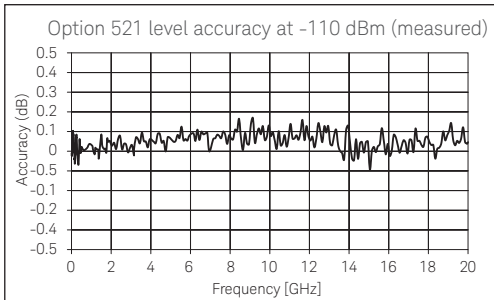
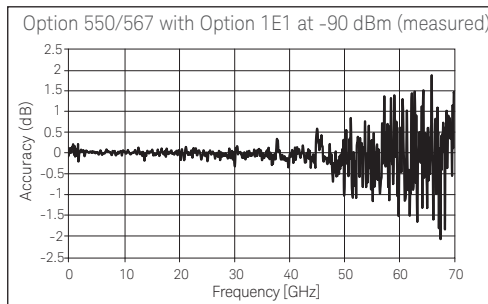
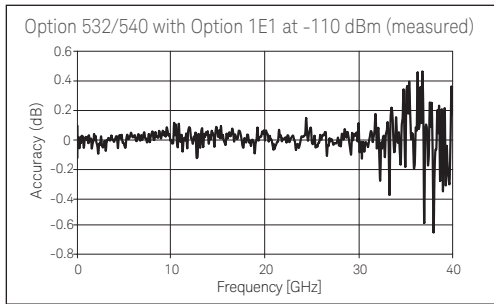
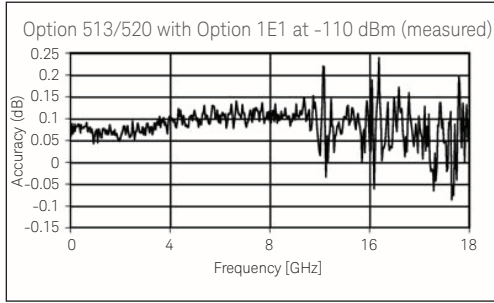

Level accuracy (measured)

<b>Resolution</b>	0.01 dB
<b>Temperature stability</b>	0.02 dB/°C (typ) <sup>1</sup>
<b>User flatness correction</b>	
Number of points	2 to 1601 points/table
Number of tables	Up to 10,000, memory limited
Path loss	Arbitrary, within attenuator range
Entry modes	Remote power meter <sup>2</sup> , remote bus, manual (user edit/view)
<b>Output impedance</b>	50 Ω (nom)
<b>SWR (internally leveled)</b>	
Options 513, 520, 532, 540, 550, 567	
250 kHz to 2 GHz	< 1.4:1 (typ) <sup>3</sup>
> 2 GHz to 20 GHz	< 1.6:1 (typ)
> 20 GHz to 40 GHz	< 1.8:1 (typ)
> 40 GHz to 67 GHz	< 2.0:1 (typ)

1. Options 550 and 567: 0.03dB/°C (typ) above 2 GHz. Option 521: 0.03 dB/°C (typ) below 500 MHz.

2. Compatible with Keysight EPM/EPM-P Series power meters.

3. For Options 550 and 567, SWR is 1.7:1 (typ) from 1.7 to 2.0 GHz when the step attenuator is set to 0 dB.

## Specifications (continued)

<b>Option 521</b>	
10 to < 500 MHz	< 6:1 (typ) without Option 1E1, or step attenuator set to 0 dB < 1.6:1 (typ) with Option 1E1 step attenuator set $\geq$ 5 dB
0.5 to 20 GHz	< 1.8:1 (typ)
<b>Leveling modes</b>	Internal leveling, external detector leveling, millimeter source module, ALC off
<b>External detector leveling</b>	
Range	-0.2 mV to -0.5 V (nom) (-36 dBm to +4 dBm using Keysight 33330D/E detector)
Bandwidth	Selectable 0.1 to 100 kHz (nom) (Note: not intended for pulsed operation)
<b>Maximum reverse power</b>	1/2 Watt, 0 V <sub>DC</sub> <sup>1</sup>
<b>Adjustable RF output limit</b>	
Function	Protects external devices by limiting maximum RF output. Operates in all leveling modes (internal, external, source module)
Range	User-adjustable from +15 dBm to maximum output power
Accuracy	
+15 to +25 dBm	$\pm$ 1 dB (typ)
> +25 dBm	$\pm$ 1.5 dB (typ)
Resolution	1 dB
Response time	30 $\mu$ sec (measured)
Adjustment	Can be locked to prevent accidental change

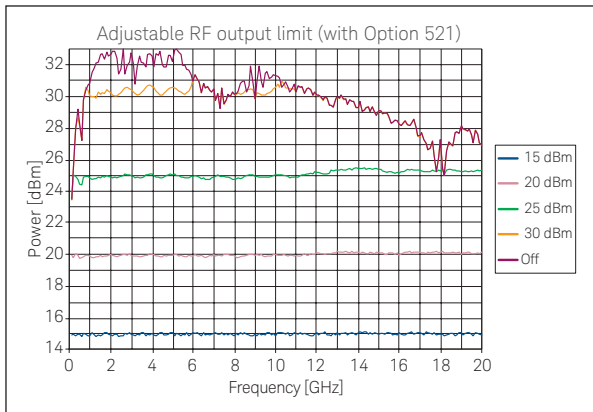

RF output limit (measured)

- For Option 521, maximum reverse power is 1/2 watt when Option 1E1 step attenuator is set at or above 5 dB. When Option 1E1 step attenuator = 0 dB, or for units without Option 1E1, maximum reverse power is 2 watts above 250 MHz, 1/2 watt below 250 MHz.

## Specifications (continued)

<b>Spectral purity</b>		
<b>Harmonics <sup>1</sup> (dBc at +10 dBm or maximum specified output power, whichever is lower)</b>		
Frequency	Options 513, 520, 532, 540, 550, 567	Option 521
< 1 MHz	-25 dBc (typ)	
1 to < 10 MHz	-25 dBc	
10 to < 60 MHz	-28 dBc	-25 dBc
10 to < 60 MHz with Option 1EH filters on	-45 dBc <sup>2</sup>	-35 dBc <sup>2, 3</sup>
10 to 250 MHz with Option HY2 in SNR mode and filters off	-8 dBc (typ)	
0.06 to 2 GHz	-30 dBc	-25 dBc
0.06 to 2 GHz with Option 1EH filters on	-55 dBc <sup>2</sup>	-35 dBc <sup>2, 3</sup>
> 0.25 to 2 GHz with Option HY2 in SNR mode and filters off	-25 dBc (typ)	
> 2 to 20 GHz	-55 dBc	-35 dBc
> 20 to 67 GHz	-50 dBc (typ)	
10 to 250 MHz, Option UNX or UNY low phase noise mode		
With Option 1EH filters off	-8 dBc (typ)	-8 dBc (typ)
With Option 1EH filters on	-55 dBc <sup>4</sup>	-35 dBc

1. Specifications are typical for harmonics beyond specified frequency range (beyond 50 GHz for Option 567). Specifications are with Option 1EH Low-pass Filters below 2 GHz off and Option UNX or UNY low phase noise mode off unless noted.
2. Below 250 MHz in ramp sweep mode (Option 007), Option 1EH filters are always off. Refer to harmonic specification with filters off.
3. Option 521 includes low-pass filters below 2 GHz as standard.
4. -45 dBc below 60 MHz.

## Specifications (continued)

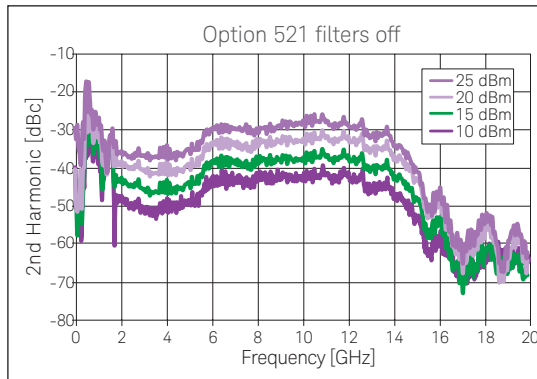
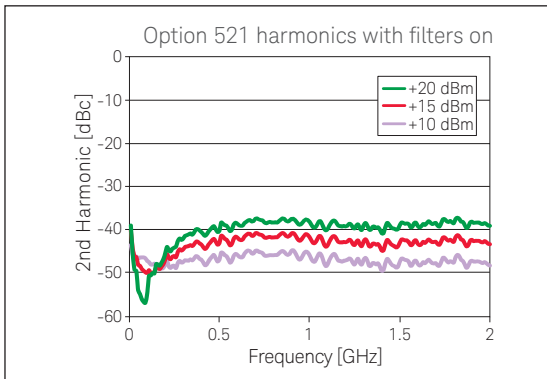
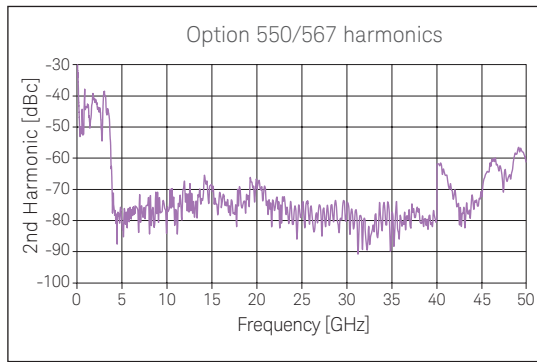
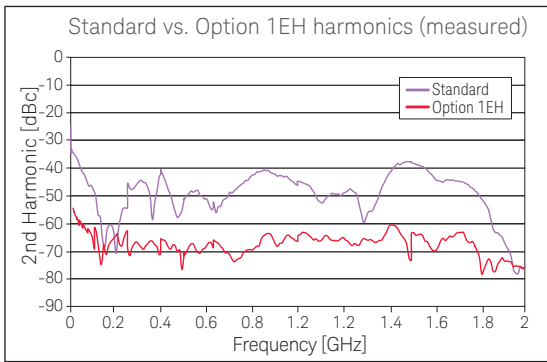
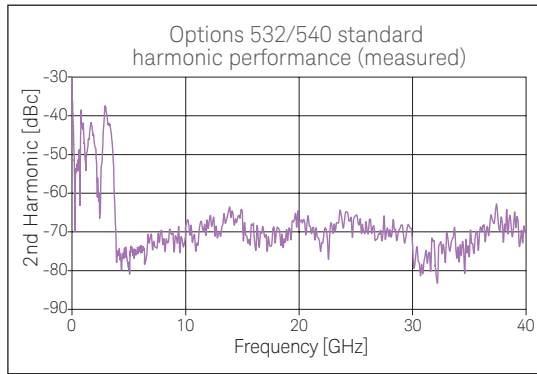
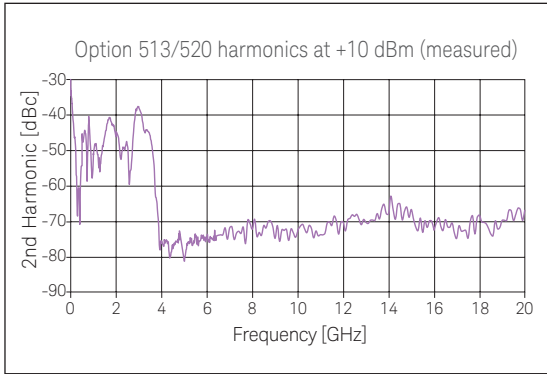

Harmonics (measured)

## Specifications (continued)

<b>Sub-harmonics <sup>1</sup> (dBc at +10 dBm or maximum specified output power, whichever is lower)</b>				
250 kHz to 10 GHz	None			
> 10 GHz to 20 GHz	< -60 dBc			
> 20 GHz	< -50 dBc			
<b>Non-harmonics <sup>2,3</sup> (dBc at +10 dBm or maximum specified output power, whichever is lower)</b>				
Frequency	Offsets > 3 kHz (standard) Spec (typ)	Offsets > 300 Hz (Opt UNX or UNY) Spec (typ)	Offsets > 3 kHz (Option UNY) Spec (typ)	Line-related ( $\leq$ 300 Hz) (typ)
250 kHz to 250 MHz	-58 (-62 <sup>4</sup> )	-58 (-62 <sup>4</sup> )	-58	(-55)
1 to 250 MHz <sup>5</sup>	-80 (-88)	-80 (-88)	-80	(-55)
> 250 MHz to 1 GHz	-80 (-88)	-80 (-88)	-80	(-55)
> 1 to 2 GHz	-74 (-82)	-74 (-82)	-80	(-55)
> 2 to 3.2 GHz	-68 (-76)	-68 (-76)	-76	(-55)
> 3.2 to 10 GHz	-62 (-70)	-62 (-70)	-70	(-50)
> 10 to 20 GHz	-56 (-64)	-56 (-64)	-64	(-45)
> 20 to 40 GHz	-50 (-58)	-50 (-58)	-58	(-39)
> 40 GHz	-44 (-52)	-44 (-52)	-52	(-37)
<b>Residual FM (RMS, 50 Hz to 15 kHz bandwidth)</b>				
CW mode	< N x 6 Hz (typ)			
CW mode with Option UNX or UNY	< N x 4 Hz (typ)			
Ramp sweep mode	< N x 1 kHz (typ)			
<b>Broadband noise (CW mode at +10 dBm or maximum specified output power, whichever is lower, for offsets &gt; 10 MHz)</b>				
10 MHz to 20 GHz (without Option 521)	< -148 dBc/Hz (typ)			
10 MHz to 20 GHz (Option 521)	< -142 dBc/Hz (typ)			
> 20 to 40 GHz	< -141 dBc/Hz (typ)			
> 40 GHz	< -135 dBc/Hz (typ)			

- Sub-harmonics are defined as carrier freq\*(x/y), where x and y are integers, and x is not an integer multiple of y. Specifications are typical for sub-harmonics beyond specified frequency range. For Option 567, specifications are typical for carrier frequencies above 50 GHz.
- Specifications are typical for spurs beyond specified frequency range (beyond 50 GHz for Option 567). Specifications apply for CW mode, without modulation. In ramp sweep mode (Option 007), performance is typical for offsets > 1 MHz.
- Excluding external mechanical vibration.
- For offsets > 10 kHz.
- Option UNX or UNY low phase noise mode.

## Specifications (continued)

<b>Measured RMS jitter<sup>1</sup></b>				
Standard carrier frequency	SONET/SDH data rates	RMS jitter bandwidth	Unit intervals ( $\mu$ UI)	Time (fs)
155 MHz	155 MB/s	100 Hz to 1.5 MHz	30	190
622 MHz	622 MB/s	1 kHz to 5 MHz	27	43
2.488 GHz	2488 MB/s	5 kHz to 20 MHz	84	34
9.953 GHz	9953 MB/s	10 kHz to 80 MHz	222	22
39.812 GHz	39812 MB/s	40 kHz to 320 MHz	804	21
Option UNX carrier frequency	SONET/SDH data rates	RMS jitter bandwidth	Unit intervals ( $\mu$ UI)	Time (fs)
155 MHz	155 MB/s	100 Hz to 1.5 MHz	7	47
622 MHz	622 MB/s	1 kHz to 5 MHz	27	43
2.488 GHz	2488 MB/s	5 kHz to 20 MHz	86	35
9.953 GHz	9953 MB/s	10 kHz to 80 MHz	197	20
39.812 GHz	39812 MB/s	40 kHz to 320 MHz	817	21
Option UNY carrier frequency	SONET/SDH data rates	RMS jitter bandwidth	Unit intervals ( $\mu$ UI)	Time (fs)
155 MHz	155 MB/s	100 Hz to 1.5 MHz	6	36
622 MHz	622 MB/s	1 kHz to 5 MHz	21	34
2.488 GHz	2488 MB/s	5 kHz to 20 MHz	53	21
9.953 GHz	9953 MB/s	10 kHz to 80 MHz	97	10
39.812 GHz	39812 MB/s	40 kHz to 320 MHz	415	10

1. Calculated from phase noise performance in CW mode only at +10 dBm. For other frequencies, data rates, or bandwidths, please contact your sales representative.



## Specifications (continued)

<b>SSB phase noise (dBc/Hz) (CW) <sup>1,2</sup></b>		<b>20 kHz offset from carrier</b>				
Frequency		Spec	Typical			
250 kHz to 250 MHz		-130	-134			
> 250 to 500 MHz		-134	-138			
> 500 MHz to 1 GHz		-130	-134			
> 1 to 2 GHz		-124	-128			
> 2 to 3.2 GHz		-120	-124			
> 3.2 to 10 GHz		-110	-113			
> 10 to 20 GHz		-104	-108			
> 20 to 40 GHz		-98	-102			
> 40 to 67 GHz		-92	-96			
<b>Option UNX: absolute SSB phase noise (dBc/Hz) (CW) <sup>1,2</sup></b>		<b>Offset from carrier</b>				
Frequency	1 Hz spec (typ)	10 Hz spec (typ)	100 Hz spec (typ)	1 kHz spec (typ)	10 kHz spec (typ)	100 kHz spec (typ)
250 kHz to 250 MHz	-58 (-66)	-87 (-94)	-104 (-120)	-121 (-128)	-128 (-132)	-130 (-133)
> 250 to 500 MHz	-61 (-72)	-88 (-98)	-108 (-118)	-125 (-132)	-132 (-136)	-136 (-141)
> 500 MHz to 1 GHz	-57 (-65)	-84 (-93)	-101 (-111)	-121 (-130)	-130 (-134)	-130 (-135)
> 1 to 2 GHz	-51 (-58)	-79 (-86)	-96 (-106)	-115 (-124)	-124 (-129)	-124 (-129)
> 2 to 3.2 GHz	-46 (-54)	-74 (-82)	-92 (-102)	-111 (-120)	-120 (-124)	-120 (-124)
> 3.2 to 10 GHz	-37 (-44)	-65 (-72)	-81 (-92)	-101 (-109)	-110 (-114)	-110 (-115)
> 10 to 20 GHz	-31 (-38)	-59 (-66)	-75 (-87)	-95 (-106)	-104 (-107)	-104 (-109)
> 20 to 40 GHz	-25 (-32)	-53 (-60)	-69 (-79)	-89 (-99)	-98 (-101)	-98 (-103)
> 40 to 67 GHz	-20 (-26)	-47 (-56)	-64 (-73)	-84 (-90)	-92 (-95)	-92 (-97)
<b>Option UNY: absolute SSB phase noise (dBc/Hz) (CW) <sup>1,2</sup></b>		<b>Offset from carrier, optimized for less than 150 kHz (mode 1)</b>				
Frequency	1 Hz spec (typ)	10 Hz spec (typ)	100 Hz spec (typ)	1 kHz spec (typ)	10 kHz spec (typ)	100 kHz spec (typ)
250 kHz to 250 MHz	-64 (-70)	-92 (-98)	-115 (-125)	-123 (-135)	-138 (-144)	-141 (-144)
> 250 to 500 MHz	-67 (-77)	-93 (-101)	-111 (-116)	-125 (-132)	-138 (-144)	-142 (-147)
> 500 MHz to 1 GHz	-62 (-69)	-91 (-99)	-105 (-111)	-121 (-128)	-138 (-143)	-138 (-144)
> 1 to 2 GHz	-57 (-63)	-86 (-90)	-100 (-106)	-115 (-121)	-133 (-138)	-133 (-139)
> 2 to 3.2 GHz	-52 (-58)	-81 (-84)	-96 (-102)	-111 (-117)	-128 (-134)	-128 (-134)
> 3.2 to 10 GHz	-43 (-49)	-72 (-76)	-85 (-91)	-101 (-107)	-120 (-126)	-120 (-125)
> 10 to 20 GHz	-37 (-43)	-66 (-70)	-79 (-85)	-95 (-101)	-114 (-121)	-114 (-119)
> 20 to 40 GHz	-31 (-37)	-60 (-66)	-73 (-79)	-89 (-95)	-108 (-113)	-108 (-113)
> 40 to 67 GHz	-26 (-32)	-54 (-60)	-68 (-73)	-84 (-90)	-102 (-107)	-102 (-107)

1. Phase noise specifications are warranted from 15 to 35 °C, excluding external mechanical vibration. Option UNY specifications at 1 kHz offset apply from 25 to 35 °C.
2. Measured at +10 dBm or maximum specified power, whichever is less.

## Specifications (continued)

Frequency	Option HY2: absolute SSB phase noise (dBc/Hz) (CW) operating in SNR mode <sup>1, 2, 3, 4</sup>							
	Offset from carrier							
	1 Hz spec (typ)	10 Hz spec (typ)	100 Hz spec (typ)	1 kHz spec (typ)	10 kHz spec (typ)	100 kHz spec (typ)	1 MHz spec (typ)	10 MHz spec (typ)
250 kHz to 1 MHz	-64 (-70)	-92 (-98)	-115 (-125)	-123 (-135)	-138 (-144)	-141 (-144)	N/A	N/A
1 MHz	-116 (-130)	-140 (-148)	-153 (-160)	-160 (-166)	-160 (-166)	-160 (-165)	N/A	N/A
10 MHz	-96 (-112)	-126 (-136)	-140 (-152)	-155 (-162)	-155 (-163)	-155 (-163)	N/A	N/A
100 MHz	-80 (-93)	-105 (-117)	-120 (-133)	-138 (-152)	-150 (-157)	-150 (-156)	-152 (-157)	-152 (-158)
250 MHz	-68 (-85)	-100 (-109)	-115 (-126)	-133 (-144)	-144 (-153)	-148 (-153)	-150 (-155)	-150 (-156)
> 250 MHz to 500 MHz	-67 (-79)	-93 (-104)	-111 (-116)	-125 (-137)	-138 (-149)	-145 (-150)	-150 (-157)	-151 (-158)
> 500 MHz to 1 GHz	-62 (-71)	-91 (-99)	-105 (-110)	-121 (-133)	-138 (-147)	-141 (-145)	-150 (-155)	-151 (-156)
> 1 GHz to 2 GHz	-57 (-67)	-86 (-92)	-100 (-107)	-115 (-129)	-133 (-141)	-134 (-139)	-147 (-152)	-155 (-160)
> 2 GHz to 3 GHz	-52 (-64)	-81 (-89)	-96 (-102)	-111 (-125)	-128 (-137)	-130 (-135)	-143 (-150)	-153 (-159)
> 3 GHz to 3.2 GHz	-52 (-58)	-81 (-84)	-96 (-102)	-111 (-125)	-128 (-137)	-128 (-134)	-145 (-148)	-147 (-153)
> 3.2 GHz to 10 GHz	-43 (-49)	-72 (-76)	-85 (-92)	-101 (-115)	-120 (-128)	-120 (-126)	-137 (-140)	-150 (-157)
> 10 GHz to 20 GHz	-37 (-43)	-66 (-70)	-79 (-85)	-95 (-101)	-114 (-121)	-114 (-119)	-129 (-133)	-145 (-152)

1. Phase noise specifications are warranted from 15 to 35 °C, excluding external mechanical vibration. Option UNY specifications at 1 kHz offset apply from 25 to 35 °C. Maximum operating temperature of Options HY2 is 35 °C.
2. Measured at +10 dBm or maximum specified power, whichever is less.
3. At carrier  $\leq 10$  MHz, the offset farthest from the carrier would be limited to  $0.99 \times$  carrier frequency.
4. At carriers  $1 \text{ MHz} \leq F \leq 250 \text{ MHz}$ , measured with filters off at +16 dBm or maximum achievable leveled power, whichever is less.

## Specifications (continued)

Option UNX: residual SSB phase noise (dBc/Hz) (CW) <sup>1,2</sup>			Offset from carrier			
Frequency	1 Hz spec (typ)	10 Hz spec (typ)	100 Hz spec (typ)	1 kHz spec (typ)	10 kHz spec (typ)	100 kHz spec (typ)
250 kHz to 250 MHz	(-94)	-100 (-107)	-110 (-118)	-120 (-126)	-128 (-132)	-130 (-133)
> 250 to 500 MHz	(-101)	-105 (-112)	-115 (-122)	-124 (-131)	-132 (-136)	-136 (-141)
> 500 MHz to 1 GHz	(-94)	-100 (-107)	-110 (-118)	-120 (-126)	-130 (-134)	-130 (-134)
> 1 to 2 GHz	(-89)	-96 (-101)	-104 (-112)	-114 (-120)	-124 (-129)	-124 (-129)
> 2 to 3.2 GHz	(-85)	-92 (-97)	-100 (-108)	-110 (-116)	-120 (-124)	-120 (-124)
> 3.2 to 10 GHz	(-74)	(-87)	(-98)	(-106)	(-114)	(-115)
Option UNY: residual SSB phase noise (dBc/Hz) (CW) <sup>1,2</sup>			Offset from carrier, optimized for less than 150 kHz (mode 1)			
Frequency	1 Hz spec (typ)	10 Hz spec (typ)	100 Hz spec (typ)	1 kHz spec (typ)	10 kHz spec (typ)	100 kHz spec (typ)
250 kHz to 250 MHz	(-94)	-100(-107)	-110 (-118)	-123 (-135)	-138 (-144)	-141 (-144)
> 250 to 500 MHz	(-101)	-105 (-112)	-115 (-122)	-124 (-130)	-138 (-144)	-140 (-147)
> 500 MHz to 1 GHz	(-94)	-100 (-108)	-110 (-118)	-120 (-126)	-135 (-142)	-135 (-145)
> 1 to 2 GHz	(-89)	-96 (-101)	-104 (-112)	-115 (-121)	-133 (-138)	-133 (-139)
> 2 to 3.2 GHz	(-85)	-92 (-97)	-100 (-108)	-111 (-117)	-128 (-134)	-128 (-134)
> 3.2 to 10 GHz	(-74)	(-87)	(-98)	(-104)	(-126)	(-125)
Option UNX: absolute SSB phase noise (dBc/Hz) (CW)						
Low phase noise mode (1 to 250 MHz) <sup>1,3</sup>			Offset from carrier			
Frequency	1 Hz spec (typ)	10 Hz spec (typ)	100 Hz spec (typ)	1 kHz spec (typ)	10 kHz spec (typ)	100 kHz spec (typ)
1 MHz	(-109)	(-120)	(-130)	(-143)	(-150)	(-150)
10 MHz	-90 (-95)	-125 (-130)	-130 (-135)	-143 (-148)	-155 (-158)	-155 (-158)
10 MHz (Option 521)	(-95)	(-115)	(-125)	(-138)	(-145)	(-145)
100 MHz	-70 (-75)	-97 (-102)	-119 (-124)	-130 (-135)	-140 (-145)	-140 (-145)
250 MHz	(-76)	(-104)	(-121)	(-138)	(-142)	(-142)
Option UNY: absolute SSB phase noise (dBc/Hz) (CW)						
Low phase noise mode (1 to 250 MHz) <sup>1,3</sup>			Offset from carrier, optimized for less than 150 kHz (mode 1)			
Frequency	1 Hz spec (typ)	10 Hz spec (typ)	100 Hz spec (typ)	1 kHz spec (typ)	10 kHz spec (typ)	100 kHz spec (typ)
1 MHz	-116 (-129)	-140 (-151)	-153 (-161)	-160 (-166)	-160 (-167)	-160 (-165)
10 MHz	-96 (-111)	-126 (-133)	-140 (-150)	-155 (-162)	-155 (-165)	-155 (-165)
10 MHz (Option 521)	(-100)	(-120)	(-135)	(-145)	(-150)	(-150)
100 MHz	-80 (-96)	-105 (-120)	-120 (-130)	-138 (-146)	-150 (-157)	-150 (-157)
100 MHz (Option 521)	-80 (-92)	-105 (-110)	-120 (-125)	-138 (-145)	-150 (-152)	-150 (-152)
250 MHz	-68 (-77)	-100 (-108)	-114 (-122)	-133 (-139)	-144 (-153)	-144 (-154)
250 MHz (Option 521)	-68 (-77)	-100 (-105)	-114 (-118)	-133 (-139)	-144 (-152)	-144 (-152)

- Phase noise specifications are warranted from 15 to 35 °C, excluding external mechanical vibration. Option UNY specifications at 1 kHz offset apply from 25 to 35 °C.
- Measured at +10 dBm or maximum specified power, whichever is less.
- Measured with filters off at +16 dBm or maximum achievable leveled power, whichever is less. Without Option 1EU, frequencies of 10 MHz and below are not specified. Without Option 1EU or 521, offsets of 10 kHz and greater are not specified.

## Specifications (continued)

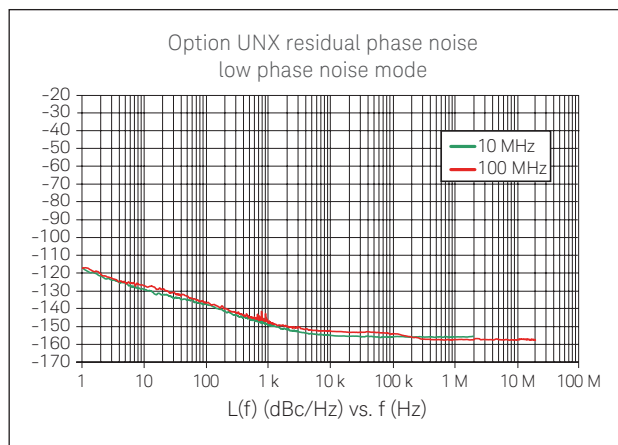
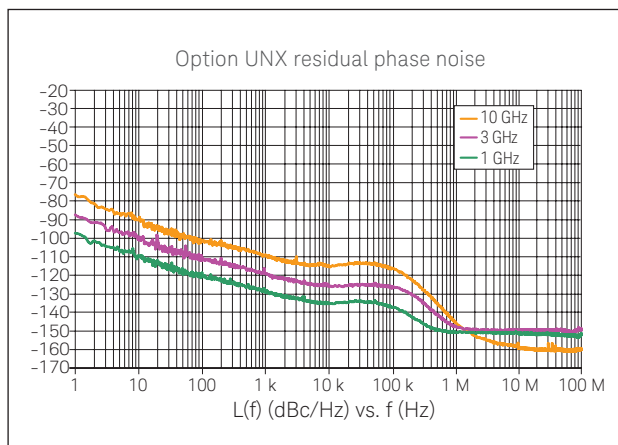
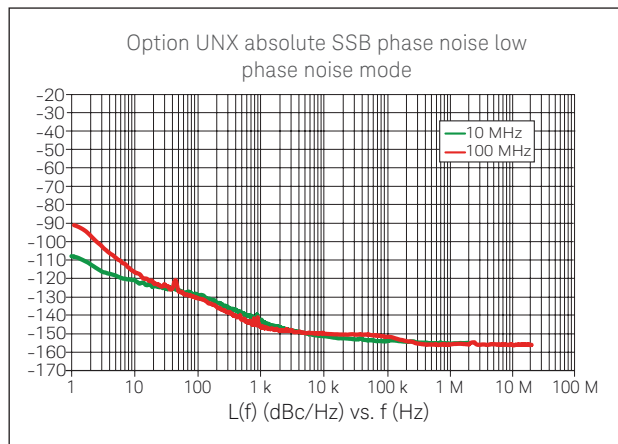
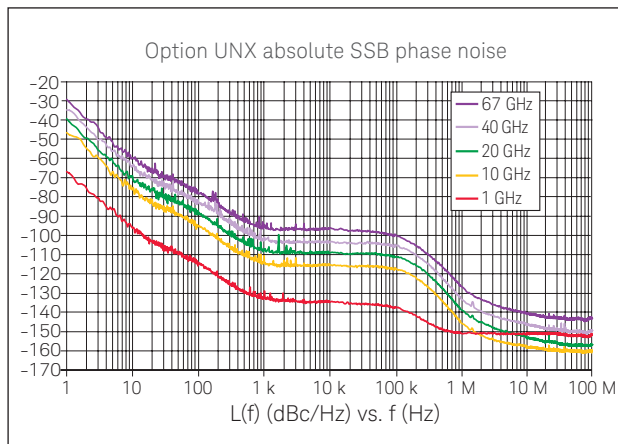
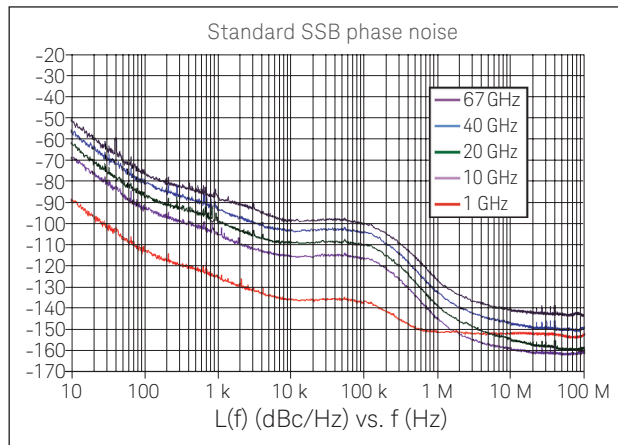
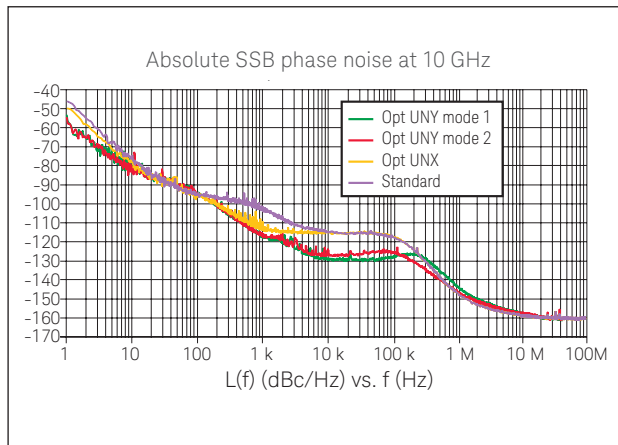

Measured phase noise (data collected with the E5500 and plotted without spurs)

## Specifications (continued)

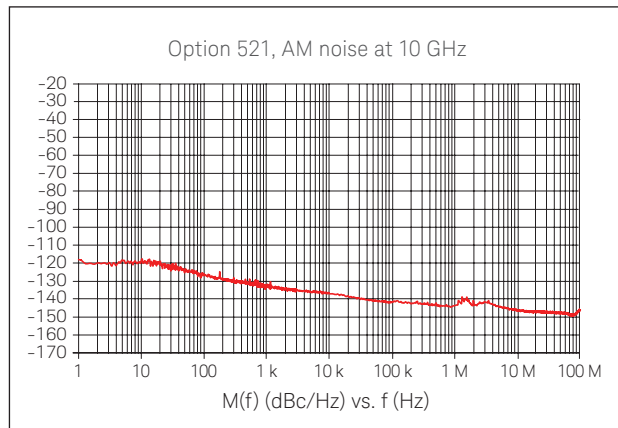
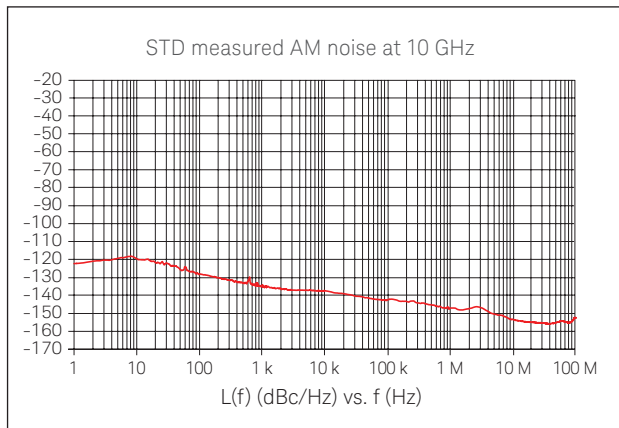
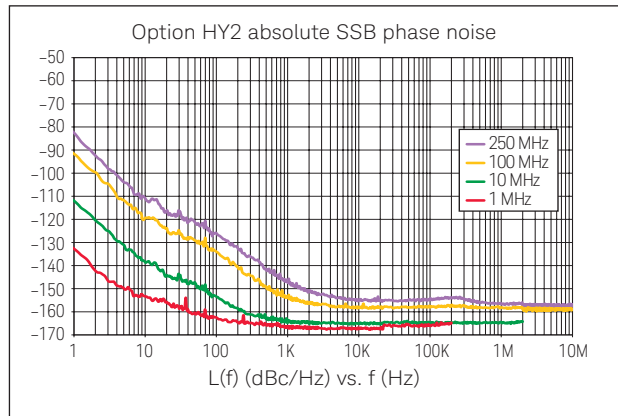
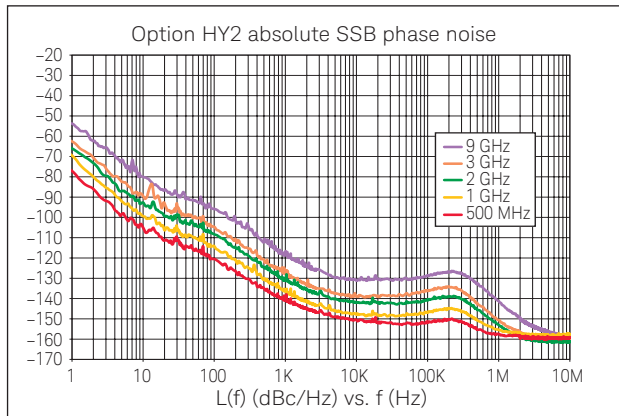
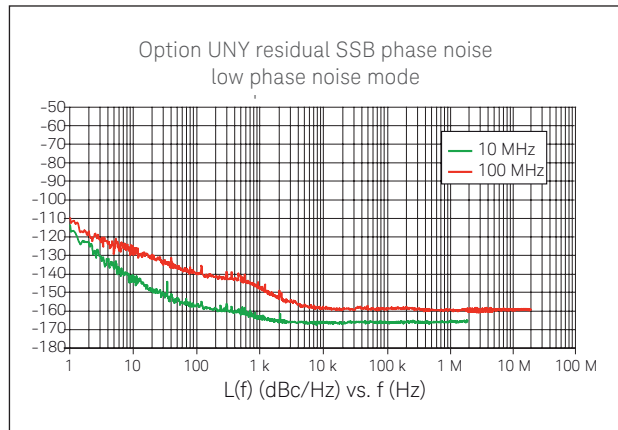
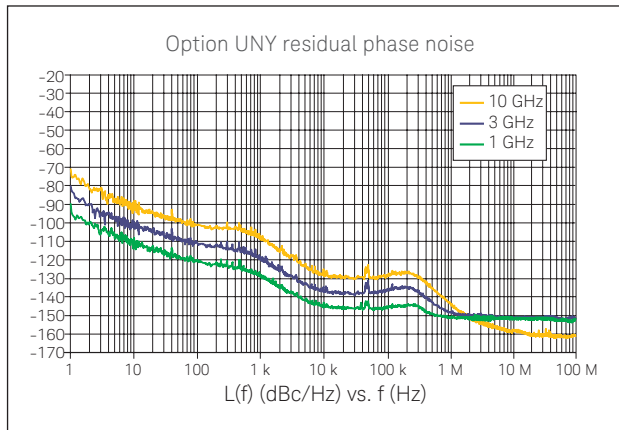
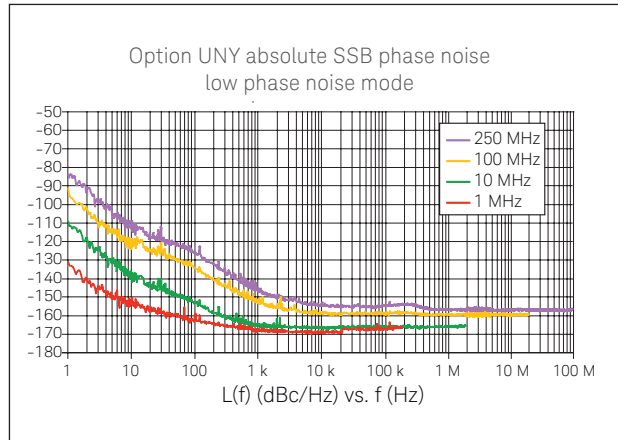
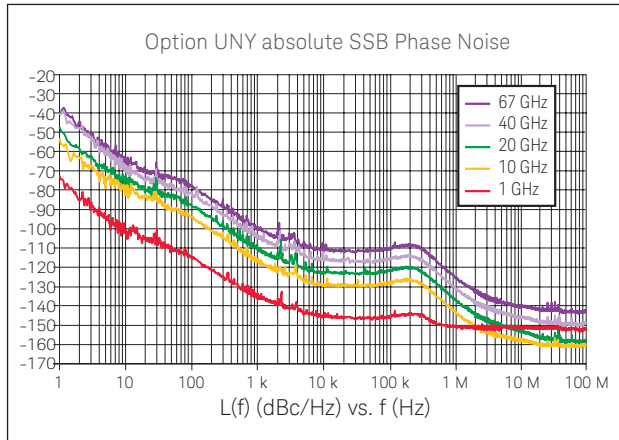

Measured phase noise (data collected with the E5500 and plotted without spurs); Option UNY phase noise optimized for offsets less than 150 kHz (mode 1)

## Specifications (continued)

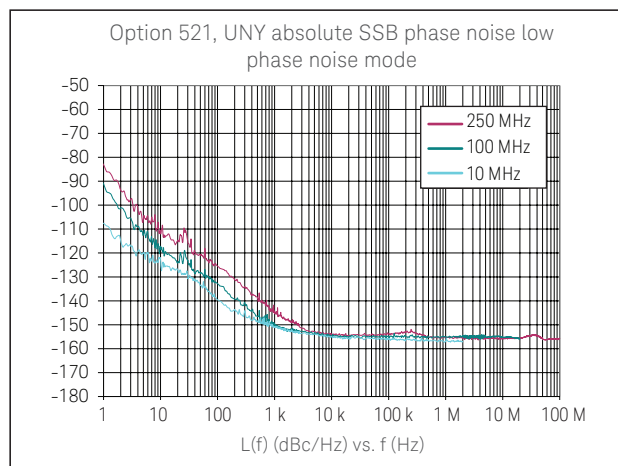
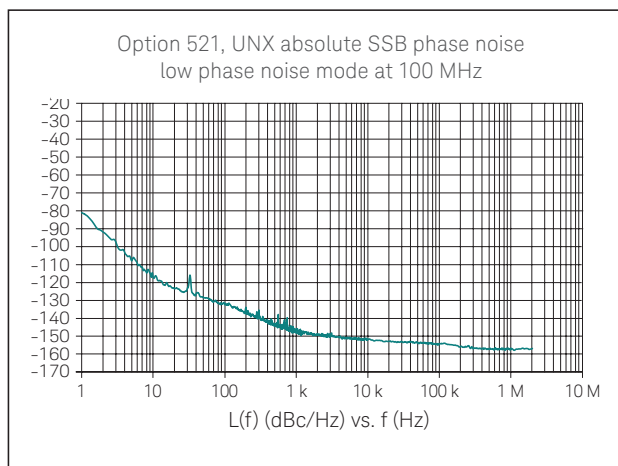
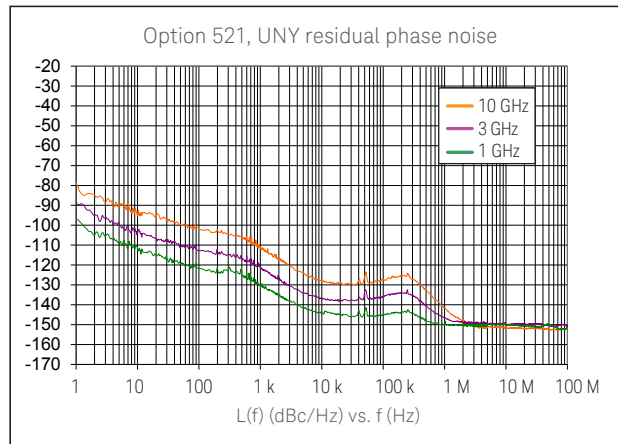
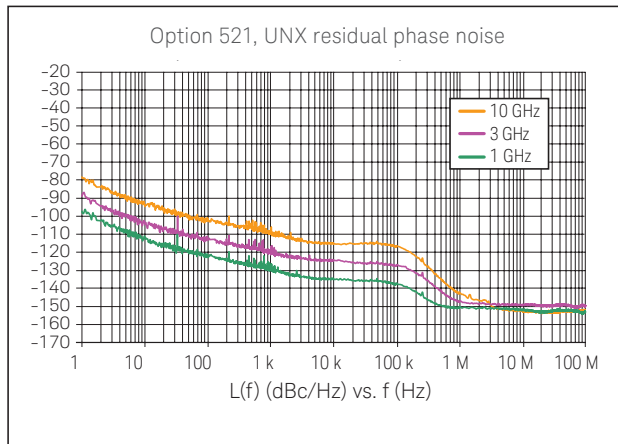
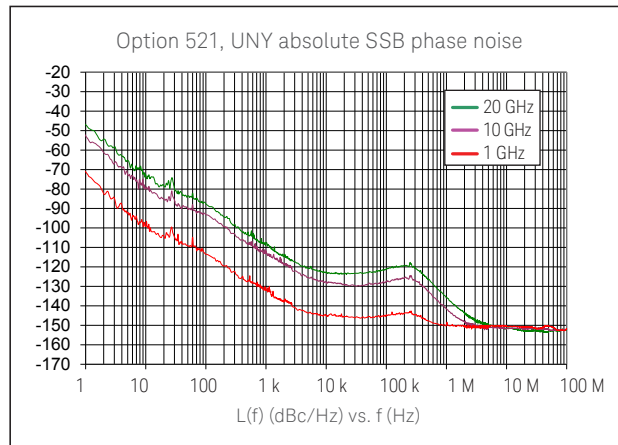
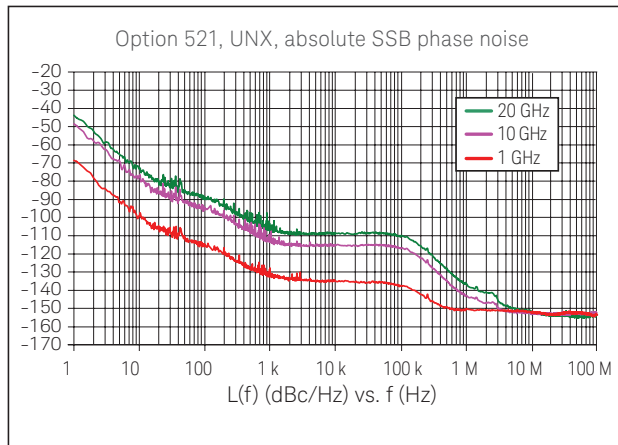

Measured phase noise (data collected with the E5500 and plotted without spurs)  
 Option UNY phase noise optimized for offsets less than 150 kHz (mode 1)

## Specifications (continued)

<b>Frequency modulation <sup>1</sup> (Option UNT)</b>		
<b>Maximum deviation <sup>2</sup></b>		
Default RF path	Frequency	Max deviation
	250 kHz to 250 MHz	2 MHz
	> 250 to 500 MHz	1 MHz
	> 500 MHz to 1 GHz	2 MHz
	> 1 GHz to 2 GHz	4 MHz
	> 2 GHz to 3.2 GHz	8 MHz
	> 3.2 GHz to 10 GHz	16 MHz
	> 10 GHz to 20 GHz	32 MHz
	> 20 GHz to 40 GHz	64 MHz
	> 40 GHz to 67 GHz	128 MHz
Option UNX or UNY low phase noise mode	Frequency	Max deviation
	> 0.98 to 1.953 MHz	3.906 kHz
	> 1.953 to 3.906 MHz	7.8125 kHz
	> 3.906 to 7.813 MHz	15.625 kHz
	> 7.813 to 15.63 MHz	31.25 kHz
	> 15.63 to 31.25 MHz	62.5 kHz
	> 31.25 to 62.5 MHz	125 kHz
	> 62.5 to 125 MHz	250 kHz
	> 125 to 250 MHz	500 kHz
Resolution	0.1% of deviation or 1 Hz, whichever is greater	
Deviation accuracy	< ± (3.5% of FM deviation + 20 Hz) (1 kHz rate, deviations < N x 800 kHz)	
<b>Modulation frequency response <sup>3</sup> (at 100 kHz deviation)</b>		
Path [coupling]	1 dB bandwidth	3 dB bandwidth (typ)
Standard or Option UNX		
FM path 1 [DC]	DC to 100 kHz	DC to 10 MHz
FM path 2 [DC]	DC to 100 kHz	DC to 1 MHz
FM path 1 [AC]	20 Hz to 100 kHz	5 Hz to 10 MHz
FM path 2 [AC]	20 Hz to 100 kHz	5 Hz to 1 MHz
Option UNY		
FM path 1 [DC]	DC to 100 kHz	DC to 9.3 MHz
FM path 2 [DC]	DC to 100 kHz	DC to 1 MHz
FM path 1 [AC]	20 Hz to 100 kHz	5 Hz to 9.3 MHz
FM path 2 [AC]	20 Hz to 100 kHz	5 Hz to 1 MHz
DC FM 4 carrier offset	± 0.1% of set deviation + (N x 8 Hz)	

1. Above 50 GHz, FM is useable; however performance is not warranted.
2. Through any combination of path1, path2, or path1 + path2.
3. Specifications apply in CW and list/step sweep modes. During ramp sweep operation (Option 007), 3 dB bandwidth is typically 50 kHz to 10 MHz (FM1 path), and 50 kHz to 1 MHz (FM2 path).
4. At the calibrated deviation and carrier frequency, within 5 °C of ambient temperature at time of user calibration.

## Specifications (continued)

<b>Distortion</b>	< 1% (1 kHz rate, deviations < N x 800 kHz)
<b>Sensitivity</b>	$\pm 1 V_{\text{peak}}$ for indicated deviation
<b>Paths</b>	FM1 and FM2 are summed internally for composite modulation. Either path may be switched to any one of the modulation sources: Ext1, Ext2, internal1, internal2. The FM2 path is limited to a maximum rate of 1 MHz. The FM2 path must be set to a deviation less than FM1. To avoid distortion and clipping, signals applied with any combination of FM1, FM2, or FM1+FM2 should not exceed $1 V_{\text{peak}}$ .

<b>Phase modulation <sup>1</sup> (Option UNT)</b>			
<b>Maximum deviation <sup>2</sup></b>			
Standard or Option UNX default RF path	Frequency	100 kHz BW mode	1 MHz BW mode
	250 kHz to 250 MHz	20 rad	2 rad
	> 250 to 500 MHz	10 rad	1 rad
	> 500 MHz to 1 GHz	20 rad	2 rad
	> 1 GHz to 2 GHz	40 rad	4 rad
	> 2 GHz to 3.2 GHz	80 rad	8 rad
	> 3.2 GHz to 10 GHz	160 rad	16 rad
	> 10 GHz to 20 GHz	320 rad	32 rad
	> 20 GHz to 40 GHz	640 rad	64 rad
	> 40 GHz to 67 GHz	1280 rad	128 rad
Option UNY default RF path	Frequency	1 MHz BW mode	10 MHz BW mode
	250 kHz to 250 MHz	2 rad	0.2 rad
	> 250 to 500 MHz	1 rad	0.1 rad
	> 500 MHz to 1 GHz	2 rad	0.2 rad
	> 1 GHz to 2 GHz	4 rad	0.4 rad
	> 2 GHz to 3.2 GHz	8 rad	0.8 rad
	> 3.2 GHz to 10 GHz	16 rad	1.6 rad
	> 10 GHz to 20 GHz	32 rad	3.2 rad
	> 20 GHz to 40 GHz	64 rad	6.4 rad
	> 40 GHz to 67 GHz	128 rad	12.8 rad
Option UNX low phase noise mode	Frequency	100 kHz BW mode	1 MHz BW mode
	> 0.98 to 1.953 MHz	0.03906 rad	0.003906 rad
	> 1.953 to 3.906 MHz	0.078125 rad	0.0078125 rad
	> 3.906 to 7.813 MHz	0.15625 rad	0.015625 rad
	> 7.813 to 15.63 MHz	0.3125 rad	0.03125 rad
	> 15.63 to 31.25 MHz	0.625 rad	0.0625 rad
	> 31.25 to 62.5 MHz	1.25 rad	0.125 rad
	> 62.5 to 125 MHz	2.5 rad	0.25 rad
> 125 to 250 MHz	5 rad	0.5 rad	

1. Above 50 GHz, phase modulation is useable; however performance is not warranted.  
 2. Through any combination of path1, path2, or path1 + path2.



## Specifications (continued)

Option UNY low phase noise mode	Frequency	1 MHz BW mode	10 MHz BW mode	
	> 0.98 to 1.953 MHz	0.003906 rad	0.0003906 rad	
	> 1.953 to 3.906 MHz	0.0078125 rad	0.00078125 rad	
	> 3.906 to 7.813 MHz	0.015625 rad	0.0015625 rad	
	> 7.813 to 15.63 MHz	0.03125 rad	0.003125 rad	
	> 15.63 to 31.25 MHz	0.0625 rad	0.00625 rad	
	> 31.25 to 62.5 MHz	0.125 rad	0.0125 rad	
	> 62.5 to 125 MHz	0.25 rad	0.025 rad	
> 125 to 250 MHz	0.5 rad	0.05 rad		
<b>Resolution</b>	0.1% of set deviation			
<b>Deviation accuracy</b>	< ± 5% of deviation + 0.01 radians (1 kHz rate with 1 MHz BW mode for Option UNY or 100 kHz BW mode otherwise)			
<b>Modulation frequency response <sup>1</sup></b>	<b>Rates (3 dB bandwidth)</b>	<b>Standard</b>	<b>UNX</b>	<b>UNY</b>
100 kHz BW mode	DC to 100 kHz	Normal	Normal	n/a
1 MHz BW mode	DC to 1 MHz (typ) <sup>2</sup>	High	High	Normal
10 MHz BW mode	DC to 10 MHz (typ)	n/a	n/a	High
<b>Distortion</b>				
Standard or Option UNX	< 1% (1 kHz rate, total harmonic distortion (THD), deviation < N x 80 rad, 100 kHz BW mode)			
Option UNY	< 1% (1 kHz rate, total harmonic distortion (THD), deviation < N x 8 rad, 1 MHz BW mode)			
<b>Sensitivity</b>	± 1 V <sub>peak</sub> for indicated deviation			
<b>Paths</b>	FM1 and FM2 are summed internally for composite modulation. Either path may be switched to any one of the modulation sources: Ext1, Ext2, internal1, internal2. The FM2 path is limited to a maximum rate of 1 MHz. The FM2 path must be set to a deviation less than FM1. To avoid distortion and clipping, signals applied with any combination of FM1, FM2, or FM1+ FM2 should not exceed 1 V <sub>peak</sub> .			

- Specifications apply in CW and list/step sweep modes. During ramp sweep operation (Option 007), 3 dB bandwidth is typically 50 kHz to 1 MHz (high BW mode).
- Path 1 is useable to 4 MHz for external inputs less than 0.3 V<sub>peak</sub>; useable to 8 MHz for external inputs less than 0.1 V<sub>peak</sub>.

## Specifications (continued)

<b>Amplitude modulation <sup>1,2</sup> (Option UNT) (typical)</b>			
Depth	Linear mode	Exponential (log) mode (downward modulation only)	
		Option UNT	Option UNT + 1SM <sup>3</sup>
<b>Maximum</b>			
ALC on	> 90%	> 20 dB	> 20 dB
ALC off with power search <sup>4</sup> or ALC on with deep AM <sup>5</sup>	> 95%	> 50 dB <sup>6</sup>	> 60 dB <sup>6</sup>
Settable	0 to 100%	0 to 40 dB	0 to 40 dB
Sensitivity	0 to 100 %/V	0 to 40 dB/V	0 to 40 dB/V
Resolution	0.1%	0.01 dB	0.01 dB
<b>Depth accuracy (1 kHz rate)</b>			
ALC on	± (6% of setting + 1%)	± (2% of setting + 0.2 dB)	± (2% of setting + 0.2 dB)
ALC off with power search <sup>4</sup> or ALC on with deep AM <sup>5</sup>			
< 2 dB depth	–	–	± 0.5 dB
< 10 dB depth	–	–	± 1 dB
< 40 dB depth	–	–	± 2 dB
< 50 dB depth	–	–	± 3 dB
< 60 dB depth	–	–	± 5 dB
<b>External input (selectable polarity)</b>			
Sensitivity for indicated depth	1 V <sub>peak</sub>	–1 V or +1 V	–1 V or +1 V
Maximum allowable	± 1 V	± 3.5 V <sup>7</sup>	± 3.5 V <sup>7</sup>
<b>Rates (3 dB bandwidth, 30% depth)</b>			
DC coupled	0 to 100 kHz		
AC coupled	10 Hz to 100 kHz (useable to 1 MHz) <sup>8</sup>		
<b>Distortion <sup>9</sup> (1 kHz rate, ALC On, linear mode, total harmonic distortion)</b>			
30% AM	< 1.5%		
60% AM	< 2%		
<b>Paths</b>	AM1 and AM2 are summed internally for composite modulation. Either path may be switched to any one of the modulation sources: Ext1, Ext2, Internal1, Internal2		

- All AM specifications are typical. For carrier frequencies below 2 MHz or above 50 GHz, AM is useable but not specified. Unless otherwise stated, specifications apply with ALC on, deep AM off, and envelope peaks within ALC operating range (–20 dBm to maximum output power, excluding step-attenuator setting.)
- Below 250 MHz with Option UNX and UNY low phase noise mode on, AM is useable but not recommended or specified.
- Option 1SM scan modulation is available with Options 513 and 520 only, and provides exponential (log) AM with improved accuracy. In this mode, maximum output power is reduced up to 3 dB below 3.2 GHz.
- ALC off is used for narrow pulse modulation and/or high AM depths with envelope peaks below ALC operating range (40 dB). Carrier power level will be accurate after a power search is executed. (See pulse modulation section for an explanation of power search).
- Deep AM with ALC on provides increased AM depths and improved distortion, together with closed-loop internal leveling. This mode must be used with a repetitive AM waveform (frequency > 10 Hz) with peaks > –5 dBm (nominal, excluding step-attenuator setting).
- Modulation depths greater than 40 dB require an external input greater than ± 1 V, and are not available with the internal modulation source.
- If 600 Ω input impedance is selected, maximum input voltage is ± 6 V.
- For Options 550 and 567, maximum rate is 80 kHz from 20 GHz to 40 GHz.
- For Option 521, distortion specifications apply for envelope peaks within the range of –15 dBm to +24 dBm, excluding step-attenuator setting.

## Specifications (continued)

<b>External modulation inputs (Ext1 &amp; Ext2) (Option UNT)</b>	
Modulation types	AM, FM, and FM
Input impedance	50 $\Omega$ or 600 $\Omega$ (nom) switched
High/low indicator	100 Hz to 10 MHz BW, activated when input level error exceeds 3% (nom), ac coupled inputs only
<b>Internal modulation source (Option UNT)</b>	
<b>Dual function generators</b>	Provide two independent signals (internal1 and internal2) for use with AM, FM, FM, or LF out.
<b>Waveforms</b>	Sine, square, positive ramp, negative ramp, triangle, Gaussian noise, uniform noise, swept sine, dual sine <sup>1</sup>
<b>Rate range</b>	
Sine	0.5 Hz to 1 MHz
Square, ramp, triangle	0.5 Hz to 100 kHz
Resolution	0.5 Hz
Accuracy	Same as timebase
<b>LF out</b>	
Output	Internal1 or internal2. Also provides monitoring of internal1 or internal2 when used for AM, FM, or FM
Amplitude	0 to 3 $V_{peak}$ (nom) into 50 $\Omega$
Output impedance	50 $\Omega$ (nom)
<b>Swept sine mode</b> (frequency, phase continuous)	
Operating modes	Triggered or continuous sweeps
Frequency range	1 Hz to 1 MHz
Sweep rate	0.5 to 100,000 sweeps/s, equivalent to sweep times 10 $\mu$ s to 2 s
Resolution	0.5 Hz (0.5 sweep/s)

1. Internal2 is not available when using swept sine or dual sine modes.

## Specifications (continued)

<b>Pulse modulation 1 (Option UNU or UNW)</b>		
<b>On/off ratio</b>	<b>Option UNU</b>	<b>Option UNW</b>
	80 dB (typ)	80 dB
<b>Rise/fall times (Tr, Tf)</b>		
Options 513, 520, 532, 540, 550, 567		
50 to 400 MHz	10 ns (typ)	15 ns (10 ns typ)
> 400 MHz	6 ns (typ)	10 ns (6 ns typ)
Option 521		
50 MHz to 1 GHz	25 ns (typ)	30 ns (25 ns typ)
1 to 3.2 GHz	12 ns (typ)	15 ns (12 ns typ)
> 3.2 GHz	6 ns (typ)	10 ns (6 ns typ)
<b>Minimum pulse width</b>		
ALC on	1 $\mu$ s	1 $\mu$ s
ALC off		
Options 513, 520, 532, 540, 550, 567		
50 to 400 MHz	150 ns	30 ns
> 400 MHz	150 ns	20 ns
Option 521		
50 MHz to 1 GHz	150 ns	60 ns
1 to 3.2 GHz	150 ns	30 ns
> 3.2 GHz	150 ns	20 ns
<b>Repetition frequency</b>		
ALC on	10 Hz to 500 kHz	10 Hz to 500 kHz
ALC off	dc to 3 MHz	dc to 10 MHz
<b>Level accuracy (relative to CW)</b>		
ALC on <sup>2</sup>	$\pm 0.5$ dB (0.15 dB typ)	$\pm 0.5$ dB (0.15 dB typ)
ALC off with power search <sup>3</sup>		
50 MHz to 3.2 GHz <sup>4</sup>	$\pm 0.7$ dB (typ)	$\pm 0.7$ dB (typ)
> 3.2 GHz	$\pm 0.5$ dB (typ)	$\pm 0.5$ dB (typ)
<b>Width compression (RF width relative to video out)</b>		
	$\pm 5$ ns (typical)	$\pm 5$ ns (typical)

1. With ALC off, specs apply after the execution of power search. Specifications apply with Atten Hold Off (default mode for instruments with attenuator), or ALC level between  $-5$  and  $+10$  dBm or maximum specified power, whichever is lower. Above 50 GHz or below 50 MHz, pulse modulation is useable; however performance is not warranted. Pulse modulation does not operate if Option UNX or UNY low phase noise mode is on.
2.  $\pm 0.8$  dB for pulse width  $\leq 1$   $\mu$ s with RF frequency  $\leq 100$  MHz
3. Power Search is a calibration routine that improves level accuracy with ALC off. The instrument microprocessor momentarily closes the ALC loop to find the modulator drive setting necessary to make the quiescent RF level equal to an entered value, then opens the ALC loop while maintaining that modulator drive setting. When executing Power Search, RF power will be present for typically 10 to 50 ms; the step attenuator (Option 1E1) can be set to automatically switch to maximum attenuation to protect sensitive devices. Power search can be configured to operate either automatically or manually at the carrier frequency, or over a user-definable frequency range. Power search may not operate above the maximum specified output power.
4.  $\pm 0.8$  dB (typical) for Option 550 and Option 567.

## Specifications (continued)

<b>Video feed-through <sup>1</sup></b>	<b>Option UNU</b>	<b>Option UNW</b>
50 to 250 MHz	< 3% (typ)	< 3% (typ)
> 250 to 400 MHz	< 11% (typ)	< 11% (typ)
> 0.4 to 3.2 GHz	< 6% (typ)	< 6% (typ)
> 3.2 GHz without Opt 521	< 2 mV pk-pk (typ)	< 2 mV pk-pk (typ)
> 3.2 GHz with Opt 521	< 50 mV pk-pk (typ)	< 50 mV pk-pk (typ)
<b>Video delay (ext input to video)</b>	50 ns (nom)	50 ns (nom)
<b>RF delay (video to RF output)</b>		
50 to 250 MHz	35 ns (nom)	35 ns (nom)
> 0.25 to 3.2 GHz	25 ns (nom)	25 ns (nom)
> 3.2 GHz	30 ns (nom)	30 ns (nom)
<b>Pulse overshoot</b>		
Without Option 521	< 10% (typ)	< 10% (typ)
With Option 521	< 20% (typ)	< 20% (typ)
<b>Input level</b>	+1 V = RF on	+1 V = RF on
<b>Input impedance</b>	50 $\Omega$ (nom)	50 $\Omega$ (nom)

1. With Option 1E1 step attenuator in 0 dB position. Above 3.2 GHz, video feed-through decreases with step attenuator setting. Below 3.2 GHz, video feed-through is expressed as a percentage of RF output level.

## Specifications (continued)

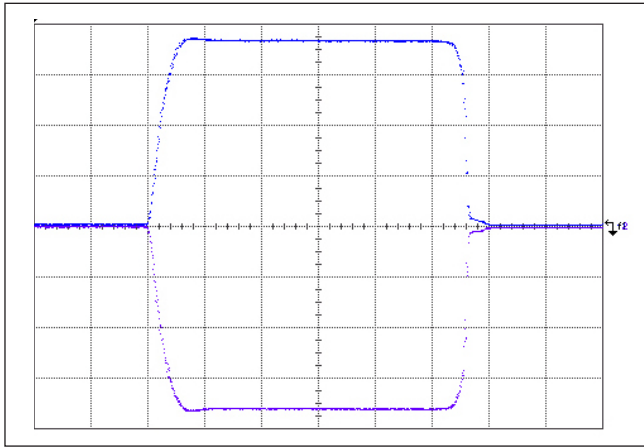

Measured pulse modulation envelope  
 Frequency = 9 GHz, amplitude = 10 dBm, ALC Off, 10 ns/div

<b>Internal pulse generator (Option UNU or UNW)</b>	
<b>Modes</b>	Free-run, triggered, triggered with delay, doublet, and gated. Triggered with delay, doublet, and gated require external trigger source.
<b>Period (PRI) (<math>T_p</math>)</b>	70 ns to 42 s (repetition frequency: 0.024 Hz to 14.28 MHz)
<b>Pulse width (<math>T_w</math>)</b>	10 ns to 42 s
<b>Delay (<math>T_d</math>)</b>	
Free-run mode	0 to $\pm 42$ s
Triggered with delay and doublet modes	75 ns to 42 s with $\pm 10$ ns jitter
<b>Resolution</b>	10 ns (width, delay, and PRI)

- $T_d$  video delay (variable)
- $T_w$  video pulse width (variable)
- $T_p$  Pulse period (variable)
- $T_m$  RF delay
- $T_{rf}$  RF pulse width
- $T_f$  RF pulse fall time
- $T_r$  RF pulse rise time
- $V_{or}$  pulse overshoot
- $V_f$  video feedthrough

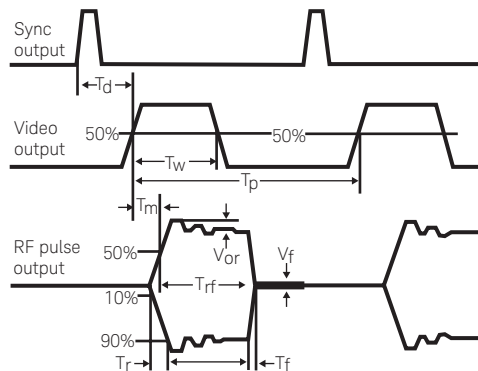

**Simultaneous modulation**  
 All modulation types (FM, AM, FM, and pulse modulation) may be simultaneously enabled except: FM with FM, and linear AM with exponential AM. AM, FM, and FM can sum simultaneous inputs from any two sources (Ext1, Ext2, internal1, or internal2). Any given source (Ext1, Ext2, internal1, or internal2) may be routed to only one activated modulation type.

## Specifications (continued)

<b>Remote programming</b>	
Interfaces	<p> GPIB (IEEE-488.2,1987) with listen and talk, RS-232, and 10BaseT LAN interface.</p>
Control languages	<p> SCPI version 1997.0. Completely code compatible with previous PSG signal generator models:</p> <ul style="list-style-type: none"> <li>– E8241A</li> <li>– E8244A</li> <li>– E8251A</li> <li>– E8254A</li> <li>– E8247C</li> <li>– E8257C</li> </ul> <hr/> <p> The E8257D will emulate the applicable commands for the following signal generators, providing general compatibility with ATE systems:</p> <ul style="list-style-type: none"> <li>– Keysight 8340-Series (8340/41B)</li> <li>– Keysight 8360-Series (836xxB/L)</li> <li>– Keysight 83700-Series (837xxB)</li> <li>– Keysight 8662A/63A</li> <li>– Keysight 8664A/8665B</li> <li>– Keysight 8643A/8644B</li> <li>– Aeroflex 2040 Series</li> </ul>
IEEE-488 functions	<p> SH1, AH1, T6, TE0, L4, LE0, SR1, RL1, PP0, DC1, DT0, C0, E2.</p>
Keysight IO libraries	<p> Keysight's IO Library Suite ships with the E8257D to help you quickly establish an error-free connection between your PC and instruments—regardless of the vendor. It provides robust instrument control and works with the software development environment you choose.</p>

## Specifications (continued)

General specifications	
Power requirements	100/120 VAC 50/60/400 Hz; or 220/240 VAC 50/60 Hz, (automatically selected); < 250 W typical, 450 W maximum
Operating temperature range	0 to 55 °C
Storage temperature range <sup>1</sup>	-40 to 70 °C
Altitude	0 to 4600 m (15,000 ft.)
Humidity	Relative humidity - type tested at 95%, +40°C (non-condensing)
Environmental testing	Samples of this product have been tested in accordance with the Keysight Environmental Test Manual and verified to be robust against the environmental stresses of storage, transportation, and end-use; those stresses include but are not limited to temperature, humidity, shock, vibration, altitude, and power line conditions. Test methods are aligned with IEC 60068-2 and levels are similar to MIL-PRF-28800F Class 3. <sup>2</sup>
ISO compliant	This family of signal generators is manufactured in an ISO-9001 registered facility in concurrence with Keysight's commitment to quality.
EMC	Conforms to the immunity and emission requirements of IEC/EN 61326-1 including the conducted and radiated emission requirements of CISPR Pub 11/2003 Group 1 class A.
Acoustic noise	Normal: 51 dBA (nom) Worst case: 62 dBA (nom) <sup>3</sup>
Storage	Memory is shared by instrument states and sweep list files. There is 14 MB of flash memory available in the E8257D PSG. Depending on how the memory is used, a maximum of 1000 instrument states can be saved.
Security	Display blanking Memory clearing functions (See Application Note, "Security Features of Keysight Technologies Signal Generators," Part Number E4400-90621) With Option 008, all user-written files are stored on an 8 GByte removable flash memory card.
Compatibility	Keysight 83550 Series millimeter heads OML millimeter source modules VDI millimeter frequency extenders Keysight 8757D scalar network analyzers Keysight EPM/EPM-P Series power meters
Self-test	Internal diagnostic routine tests most modules (including microcircuits) in a preset condition. For each module, if its node voltages are within acceptable limits, then the module "passes" the test.
Weight	< 22 kg (48 lb.) net, < 30 kg (68 lb.) shipping
Dimensions	178 mm H x 426 mm W x 515 mm D (7" H x 16.8" W x 20.3" D)
Recommended calibration cycle	24 months

1. During storage below -20 °C, instrument states may be lost.

2. As is the case with all signal generation equipment, phase noise specifications are not warranted in a vibrating environment.

3. This is louder than typical Keysight equipment: 60 dBA (nom).



## Input/Output Descriptions

Front panel connectors (all connectors are BNC female unless otherwise noted.) <sup>1</sup>	
RF output	Output impedance 50 $\Omega$ (nom)
Options 513, 520 and 521	Precision APC-3.5 male, or Type-N female with Option 1ED ⚠ Caution: Option 521 output power > 1 Watt
Options 532, 540, and 550	Precision 2.4 mm male; plus 2.4 – 2.4 mm and 2.4 – 2.9 mm female adapters
Option 567	Precision 1.85 mm male; plus 1.85 – 1.85 mm and 2.4 – 2.9 mm female adapters
ALC input	Used for negative external detector leveling. Nominal input impedance 120 k $\Omega$ , damage level $\pm$ 15 V.
LF output	Outputs the internally generated LF source. Nominal output impedance 50 $\Omega$ .
External input 1	Drives either AM, FM, or FM. Nominal input impedance 50 or 600 $\Omega$ , damage levels are 5 $V_{rms}$ and 10 $V_{peak}$ .
External input 2	Drives either AM, FM, or FM. Nominal input impedance 50 or 600 $\Omega$ , damage levels are 5 $V_{rms}$ and 10 $V_{peak}$ .
Pulse/trigger gate input	Accepts input signal for external fast pulse modulation. Also accepts external trigger pulse input for internal pulse modulation. Nominal impedance 50 $\Omega$ . Damage levels are 5 $V_{rms}$ and 10 $V_{peak}$ .
Pulse video out	Outputs a signal that follows the RF output in all pulse modes. TTL-level compatible, nominal source impedance 50 $\Omega$ .
Pulse sync out	Outputs a synchronizing pulse, nominally 50 ns width, during internal and triggered pulse modulation. TTL-level compatible, nominal source impedance 50 $\Omega$ .

1. Digital inputs and outputs are 3.3 V CMOS unless indicated otherwise. Inputs will accept 5 V CMOS, 3 V CMOS, or TTL voltage levels.

## Input/Output Descriptions (continued)

### Rear panel connectors (All connectors are BNC female unless otherwise noted.)<sup>1</sup>

Auxiliary interface (dual mode)	Used for RS-232 serial communication and for master/slave source synchronization. (9-pin subminiature female connector). For master/slave operation, use Keysight part number 8120-8806 master/slave interface cable.
GPIO	Allows communication with compatible devices
LAN	Allows 10BaseT LAN communication
10 MHz input	Accepts a 10 MHz external reference (timebase) input. Nominal input impedance 50 $\Omega$ Damage levels > +10 dBm
10 MHz output	Outputs internal or external reference signal. Nominal output impedance 50 $\Omega$ . Nominal output power +8 dBm.
Sweep output (dual mode)	Supplies a voltage proportional to the RF power or frequency sweep ranging from 0 volts at the start of sweep to +10 volts (nom) at the end of sweep, regardless of sweep width. During CW operation, supplies a voltage proportional to the output frequency, +10 volts (nom) corresponding to the maximum specified frequency. When connected to a Keysight 8757D scalar network analyzer (Option 007), generates a selectable number of equally spaced 1 $\mu$ s pulses (nom) across a ramp (analog) sweep. Number of pulses can be set from 101 to 1601 by remote control from the 8757D. Output impedance: < 1 $\Omega$ (nom), can drive 2 k $\Omega$ .
Stop sweep in/out	Open-collector, TTL-compatible input/output. In ramp sweep operation, provides low level (nominally 0 V) during sweep retrace and bandcross intervals, and high level during the forward portion of the sweep. Sweep will stop when grounded externally, sweep will resume when allowed to go high.
Trigger output (dual mode)	Outputs a TTL signal. High at start of dwell, or when waiting for point trigger; low when dwell is over or point trigger is received. In ramp sweep mode, provides 1601 equally-spaced 1 $\mu$ s pulses (nom) across a ramp sweep. When using LF Out, provides 2 $\mu$ s pulse at start of LF sweep.
Trigger input	Accepts 3.3 V CMOS signal for triggering point-to-point in manual sweep mode, or to trigger start of LF sweep. Damage levels $\geq$ +10 V or $\leq$ -4 V.
Source module interface	Keysight 83550 Series mm source modules: Provides bias, flatness correction and leveling connections. OML SxxMS-AG mm source modules: Provides power to the module and returns frequency multiplication information from the module.
Source settled	Provides an output trigger that indicates when the signal generator has settled to a new frequency or power level. High indicates source not settled, Low indicates source settled.
Z-axis blank/markers	During ramp sweep, supplies +5 V (nom) level during retrace and bandswitch intervals. Supplies -5 V (nom) level when the RF frequency is at a marker frequency.
10 MHz EFC	(Option UNX or UNY) Accepts an external DC voltage, ranging from -5 V to +5 V, for electronic frequency control (EFC) of the internal 10 MHz reference oscillator. This voltage inversely tunes the oscillator about its center frequency approximately -0.07 ppm/V. The nominal input impedance is greater than 1 M $\Omega$ .
1 GHz out	(Option UNX or UNY) Low noise 1 GHz reference output signal, approximately +5 dBm (nom).
Removable flash memory drive	Accepts 8 GB compact flash memory card for optional non-volatile memory (Option 008 only). All user information (Save/Recall settings, flatness files, presets, etc) is stored on removable memory card when Option 008 is installed.

1. Digital inputs and outputs are 3.3 V CMOS unless indicated otherwise. Inputs will accept 5 V CMOS, 3 V CMOS, or TTL voltage levels.

## Options, Accessories, and Related Products

Model/option	Description
E8257D-513	Frequency range from 250 kHz to 13 GHz
E8257D-520	Frequency range from 250 kHz to 20 GHz
E8257D-521	Ultrahigh output power, frequency range from 10 MHz to 20 GHz
E8257D-532	Frequency range from 250 kHz to 31.8 GHz
E8257D-540	Frequency range from 250 kHz to 40 GHz
E8257D-550	Frequency range from 250 kHz to 50 GHz
E8257D-567	Frequency range from 250 kHz to 67 GHz
E8257D-007	Analog ramp sweep
E8257D-008	8 GB removable flash memory
E8257D-UNX	Ultra low phase noise
E8257D-UNY	Enhanced ultra-low phase noise
E8257D-HY2	Enhanced ultra-low phase noise level 2
E8257D-UNT	AM, FM, phase modulation, and LF output
E8257D-UNU	Pulse modulation
E8257D-UNW	Narrow pulse modulation
E8257D-1E1	Step attenuator
E8257D-1ED	Type-N (f) RF output connector (Option 513, 520 and 521 only)
E8257D-1EH	Improved harmonics below 2 GHz (low-pass filters standard with Option 521)
E8257D-1EM	Moves all front panel connectors to the rear panel
E8257D-1EU	High output power (standard with Option 521)
E8257D-1CN	Front handle kit
E8257D-1CM	Rackmount flange kit
E8257D-1CP	Rackmount flange and front handle kit
E8257D-1SM <sup>1</sup>	Scan modulation (Option 513 and 520 only)
E8257D-C09	Move all front panel connectors to the rear panel except for the RF output connector
E8257D-UK6	Commercial calibration certificate and test data
E8257D-A6J	ANSI Z540-1-1994 calibration
E8257D-1A7	Calibration + uncertainties + guardbanding
E8257D-AMG	Calibration + uncertainties + guardbanding (accredited)
E8257D-CD1	CD-ROM containing the English documentation set
E8257D-ABA	Printed copy of the English documentation set
<b>Customized product solutions</b>	
E8257D-H1S	1 GHz external frequency reference input and output
E8257D-HCC	Connections for phase coherency > 250 MHz
<b>Accessories</b>	
8120-8806	Master/slave interface cable
1819-0427	8 GByte compact flash memory card
E8251-60419	Rack slide kit

1. Requires Option UNT and Option 520.

## Related Keysight Literature

*Keysight Microwave Signal Generators*

Brochure, Literature number 5991-4876EN

*E8257D PSG Microwave Analog Signal Generators Configuration Guide,*

Configuration Guide, Literature number 5989-1325EN

*E8267D PSG Microwave Vector Signal Generator*

Data Sheet, Literature number 5989-0697EN

*E8267D PSG Microwave Vector Signal Generator*

Configuration Guide, Literature number 5989-1326EN

*E8663D PSG RF Analog Signal Generator*

Data Sheet, Literature number 5990-4136EN

*E8663D PSG RF Analog Signal Generator*

Configuration Guide, Literature number 5990-4137EN

*Millimeter Wave Source Modules from OML, Inc. for the*

Keysight PSG Signal Generators

Technical Overview Literature number 5989-2923EN

*Security Features of Keysight Technologies Signal Generators*

Part Number E4400-90621

## Web Resources

For additional product information, visit:

[www.keysight.com/find/psg](http://www.keysight.com/find/psg)

For accessory information, visit:

[www.keysight.com/find/accessories](http://www.keysight.com/find/accessories)

For additional description of Keysight's IO Libraries Suite features and installation requirements, please go to:

[www.keysight.com/find/iosuite/database](http://www.keysight.com/find/iosuite/database)

## Evolving Since 1939

Our unique combination of hardware, software, services, and people can help you reach your next breakthrough. We are unlocking the future of technology.

From Hewlett-Packard to Agilent to Keysight.



For more information on Keysight Technologies' products, applications or services, please contact your local Keysight office. The complete list is available at: [www.keysight.com/find/contactus](http://www.keysight.com/find/contactus)

### Americas

Canada	(877) 894 4414
Brazil	55 11 3351 7010
Mexico	001 800 254 2440
United States	(800) 829 4444

### Asia Pacific

Australia	1 800 629 485
China	800 810 0189
Hong Kong	800 938 693
India	1 800 11 2626
Japan	0120 (421) 345
Korea	080 769 0800
Malaysia	1 800 888 848
Singapore	1 800 375 8100
Taiwan	0800 047 866
Other AP Countries	(65) 6375 8100

### Europe & Middle East

Austria	0800 001122
Belgium	0800 58580
Finland	0800 523252
France	0805 980333
Germany	0800 6270999
Ireland	1800 832700
Israel	1 809 343051
Italy	800 599100
Luxembourg	+32 800 58580
Netherlands	0800 0233200
Russia	8800 5009286
Spain	800 000154
Sweden	0200 882255
Switzerland	0800 805353
	Opt. 1 (DE)
	Opt. 2 (FR)
	Opt. 3 (IT)
United Kingdom	0800 0260637

For other unlisted countries: [www.keysight.com/find/contactus](http://www.keysight.com/find/contactus) (BP-9-7-17)

**DEKRA Certified**  
ISO 9001 Quality Management System

[www.keysight.com/go/quality](http://www.keysight.com/go/quality)  
Keysight Technologies, Inc.  
DEKRA Certified ISO 9001:2015  
Quality Management System

### myKeysight

#### myKeysight

[www.keysight.com/find/mykeysight](http://www.keysight.com/find/mykeysight)

A personalized view into the information most relevant to you.

[www.keysight.com/find/emt\\_product\\_registration](http://www.keysight.com/find/emt_product_registration)

Register your products to get up-to-date product information and find warranty information.

### KEYSIGHT SERVICES

Accelerate Technology Adoption.  
Lower costs.

#### Keysight Services

[www.keysight.com/find/service](http://www.keysight.com/find/service)

Keysight Services can help from acquisition to renewal across your instrument's lifecycle. Our comprehensive service offerings—one-stop calibration, repair, asset management, technology refresh, consulting, training and more—helps you improve product quality and lower costs.



#### Keysight Assurance Plans

[www.keysight.com/find/AssurancePlans](http://www.keysight.com/find/AssurancePlans)

Up to ten years of protection and no budgetary surprises to ensure your instruments are operating to specification, so you can rely on accurate measurements.

#### Keysight Channel Partners

[www.keysight.com/find/channelpartners](http://www.keysight.com/find/channelpartners)

Get the best of both worlds: Keysight's measurement expertise and product breadth, combined with channel partner convenience.

[www.keysight.com/find/E8257D](http://www.keysight.com/find/E8257D)



Unlocking Measurement Insights

This information is subject to change without notice.  
© Keysight Technologies, 2010 - 2017  
Published in USA, December 1, 2017  
5989-0698EN  
[www.keysight.com](http://www.keysight.com)