

Agilent U2000 Series USB Power Sensors

Operating and Service Guide



Agilent Technologies

Notices

© Agilent Technologies, Inc. 2007-2010

No part of this manual may be reproduced in any form or by any means (including electronic storage and retrieval or translation into a foreign language) without prior agreement and written consent from Agilent Technologies, Inc. as governed by United States and international copyright laws.

Manual Part Number

U2000-90405

Edition

Fifth Edition, April 29, 2010

Printed in Malaysia

Agilent Technologies, Inc.
5301 Stevens Creek Blvd.
Santa Clara, CA 95051 USA

Trademark Acknowledgements

Microsoft is a U.S. registered trademark of Microsoft Corporation.

LabVIEW is a registered trademark of National Instruments.

Warranty

The material contained in this document is provided “as is,” and is subject to being changed, without notice, in future editions. Further, to the maximum extent permitted by applicable law, Agilent disclaims all warranties, either express or implied, with regard to this manual and any information contained herein, including but not limited to the implied warranties of merchantability and fitness for a particular purpose. Agilent shall not be liable for errors or for incidental or consequential damages in connection with the furnishing, use, or performance of this document or of any information contained herein. Should Agilent and the user have a separate written agreement with warranty terms covering the material in this document that conflict with these terms, the warranty terms in the separate agreement shall control.

Technology Licenses

The hardware and/or software described in this document are furnished under a license and may be used or copied only in accordance with the terms of such license.

Restricted Rights Legend

U.S. Government Restricted Rights. Software and technical data rights granted to the federal government include only those rights customarily provided to end user customers. Agilent provides this customary commercial license in Software and technical data pursuant to FAR 12.211 (Technical Data) and 12.212 (Computer Software) and, for the Department of Defense, DFARS 252.227-7015 (Technical Data - Commercial Items) and DFARS 227.7202-3 (Rights in Commercial Computer Software or Computer Software Documentation).

Safety Notices

CAUTION

A **CAUTION** notice denotes a hazard. It calls attention to an operating procedure, practice, or the like that, if not correctly performed or adhered to, could result in damage to the product or loss of important data. Do not proceed beyond a **CAUTION** notice until the indicated conditions are fully understood and met.

WARNING

A **WARNING** notice denotes a hazard. It calls attention to an operating procedure, practice, or the like that, if not correctly performed or adhered to, could result in personal injury or death. Do not proceed beyond a **WARNING** notice until the indicated conditions are fully understood and met.

Certification

Agilent Technologies certifies that this product met its published specifications at the time of shipment from the factory. Agilent Technologies further certifies that its calibration measurements are traceable to the United States National Institute of Standard and Technology, to the extent allowed by the Institute's calibration facility, and to the calibration facilities of other International Standard Organization members.

Limitation of Warranty

The foregoing warranty shall not apply to defects resulting from improper or inadequate maintenance by Buyer, Buyer-supplied software or interfacing, unauthorized modification or misuse, operation outside of the environmental specifications for the product, or improper site preparation or maintenance. NO OTHER WARRANTY IS EXPRESSED OR IMPLIED. AGILENT TECHNOLOGIES SPECIFICALLY DISCLAIMS THE IMPLIED WARRANTIES OF MERCHANTABILITY AND FITNESS FOR A PARTICULAR PURPOSE.

Exclusive Remedies

THE REMEDIES PROVIDED HEREIN ARE BUYER'S SOLE AND EXCLUSIVE REMEDIES. AGILENT TECHNOLOGIES SHALL NOT BE LIABLE FOR ANY DIRECT, INDIRECT, SPECIAL, INCIDENTAL, OR CONSEQUENTIAL DAMAGES, WHETHER BASED ON CONTRACT, TORT, OR ANY OTHER LEGAL THEORY.

Safety Summary

The following general safety precautions must be observed during all phases of operation of this instrument. Failure to comply with these precautions or with specific warnings elsewhere in this manual violates safety standards of design, manufacture, and intended use of the instrument. Agilent Technologies, Inc. assumes no liability for the customer's failure to comply with these requirements.

Safety Notices

WARNING

















A **WARNING** notice denotes a hazard. It calls attention to an operating procedure, practice, or the like that, if not correctly performed or adhered to, could result in personal injury or loss of life. Do not proceed beyond a **WARNING** notice until the indicated conditions are fully understood and met.

CAUTION





A **CAUTION** notice denotes a hazard. It calls attention to an operating procedure, practice, or the like that, if not correctly performed or adhered to, could result in damage to the product or loss of important data. Do not proceed beyond a **CAUTION** notice until the indicated conditions are fully understood and met.

Safety Symbols

The following symbols on the instrument and in the documentation indicate precautions which must be taken to maintain safe operation of the instrument.

	Direct current		On (supply)
	Alternating current		Off (supply)
	Both direct and alternating current		Equipotential protected throughout by DOUBLE INSULATION or REINFORCED INSULATION
	Three-phase alternating current		Caution, risk of electric shock.
	Earth (ground) terminal		Caution, risk of danger (refer to this manual for specific Warning or Caution information).
	Protective conductor terminal		Caution, hot surface.
	Frame or chassis terminal		Out position of a bi-stable push control.
	Equipotentiality		In position of a bi-stable push control.

Regulatory Markings

 <p>ESD Sensitive</p>	<p>This symbol indicates that a device, or part of a device, may be susceptible to electrostatic discharges (ESD) which can result in damage to the product. Observe ESD precautions given on the product, or its user documentation, when handling equipment bearing this mark.</p>
	<p>The CE mark shows that the product complies with all the relevant European Legal Directives.</p>
	<p>The C-tick mark is a registered trademark of the Spectrum management Agency of Australia. This signifies compliance with the Australian EMC Framework regulations under the terms of the Radio Communications Act of 1992.</p>
	<p>This product complies with the WEEE Directive (2002/96/EC) marking equipment. The affixed product label indicates that you must not discard this electrical/electronic product in domestic household waste.</p>
<p>ICES/NMB - 001</p>	<p>ICES/NMB-001 indicates that this ISM device complies with Canadian ICES-001. Cet appareil ISM est conforme à la norme NMB-001 du Canada</p>

Waste Electrical and Electronic Equipment (WEEE) Directive 2002/96/EC

This instruction complies with the WEEE Directive (2002/96/EC) marking requirement. This affixed product label indicates that you must not discard this electrical/electronic product in domestic household waste.

Product Category:

With reference to the equipment types in the WEEE Directive Annex 1, this instrument is classified as a "Monitoring and Control Instrument" product.

The affixed product label is shown as below:



Do not dispose in domestic household waste

To return this unwanted instrument, contact your nearest Agilent office, or visit

www.agilent.com/environment/product

for more information.

General Safety Information

The following general safety precautions must be observed during all phases of operation of this instrument. Failure to comply with these precautions or with specific warnings elsewhere in this manual violates safety standards of design, manufacture, and intended use of the instrument. Agilent Technologies, Inc. assumes no liability for the customer's failure to comply with these requirements.

WARNING

BEFORE CONNECTING THE POWER SENSOR TO OTHER INSTRUMENTS ensure that all instruments are connected to the protective (earth) ground. Any interruption of the protective earth grounding will cause a potential shock hazard that could result in personal injury.

CAUTION

- Use the device with the cables provided.
 - Repair or service that is not covered in this manual should only be performed by qualified personnel.
-

Environmental Conditions

This instrument is designed for indoor use only. The table shows the general requirements for the product.

Environmental Conditions	Requirements
Temperature	0 °C to +55 °C (operating) –30 °C to +70 °C (non-operating)
Humidity	Operating up to 95% at 40 °C (non-condensing) Non-operating up to 90% at 65 °C (non-condensing)
Altitude	Operating up to 4,600 metres (15,000 feet) Non-operating up to 4,600 metres (15, 000 feet)
Pollution	Degree 2

CAUTION

The Agilent U2000 Series USB power sensors comply with the following safety and EMC requirements:

- IEC 61010-1:2001 / EN 61010-1:2001 (2nd edition)
- IEC 61326:2002 / EN61326:1997+A1:1998+A2:2001+A3:2003
- Canada: ICES-001:2004
- Australia/New Zealand: AS/NZS CISPR11:2004



Agilent Technologies

DECLARATION OF CONFORMITY
According to EN ISO/IEC 17050-1:2004



Manufacturer's Name: Agilent Technologies Microwave Products (M) Sdn. Bhd
Manufacturer's Address: Bayan Lepas Free Industrial Zone,
11900, Bayan Lepas, Penang, Malaysia

Declares under sole responsibility that the product as originally delivered

Product Name: Agilent U2000 Series USB Power Sensor
Models Number: U2000A, U2000B, U2000H, U2001A, U2001B, U2001H,
U2002A, U2002H, U2004A
Product Options: This declaration covers all options of the above product(s)

complies with the essential requirements of the following applicable European Directives, and carries the CE marking accordingly:

Low Voltage Directive (2006/95/EC)
EMC Directive (2004/108/EC)

and conforms with the following product standards:

EMC	Standard	Limit
	IEC 61326:2002 / EN 61326:1997+A1:1998+A2:2001+A3:2003	
	CISPR 11:1990 / EN55011:1990	Class A Group 1
	IEC 61000-4-2:1995 / EN 61000-4-2:1995	4 kV CD, 8 kV AD
	IEC 61000-4-3:1995 / EN 61000-4-3:1996	3 V/m, 80-1000 MHz
	IEC 61000-4-4:1995 / EN 61000-4-4:1995	0.5 kV signal lines, 1 kV power lines
	IEC 61000-4-5:1995 / EN 61000-4-5:1995	0.5 kV line-line, 1 kV line-ground
	IEC 61000-4-6:1996 / EN 61000-4-6:1996	3 V, 0.15-80 MHz
	IEC 61000-4-11:1994 / EN 61000-4-11:1994	1 cycle / 100%

Canada: ICES-001:2004
Australia/New Zealand: AS/NZS CISPR11:2004

The product was tested in a typical configuration with Agilent Technologies test systems.

Safety IEC 61010-1:2001 / EN 61010-1:2001

This DoC applies to above-listed products placed on the EU market after:

03-July-2008

Date

Tay Eng Su

Quality Manager

For further information, please contact your local Agilent Technologies sales office, agent or distributor,
or Agilent Technologies Deutschland GmbH, Herrenberger Straße 130, 71034 Böblingen, Germany.

Product Regulations

EMC

IEC 61326-1:2002 / EN 61326-1:1997+A1:1998+A2:2001+A3:2003

CISPR 11:1990 / EN 55011:1990 – Group 1 Class A

IEC 61000-4-2:1995 / EN 61000-4-2:1995 (ESD 4kV CD, 8kV AD)

IEC 61000-4-3:1995 / EN 61000-4-3:1996 (3V/m, 80% AM)

IEC 61000-4-4:1995 / EN 61000-4-4:1995 (EFT 0.5kV line-line, 1kV line-earth)

IEC 61000-4-5:1995 / EN 61000-4-5:1995 (Surge 0.5kV line-line, 1kV line-earth)

IEC 61000-4-6:1996 / EN 61000-4-6:1996 (3V, 0.15-80 MHz, 80% AM, power line)

IEC 61000-4-11:1994 / EN 61000-4-11:1994 (Dips 1 cycle, 100%)

Canada: ICES-001:2004

Australia/New Zealand: AS/NZS CISPR11:2004

Performance Criteria

A
A
B
B
A
B

Safety IEC 61010-1:2001 / EN 61010-1:2001

Additional Information:

The product herewith complies with the essential requirements of the Low Voltage Directive 2006/95/EC and the EMC Directive 2004/108/EC and carries the CE Marking accordingly (European Union).

¹Performance Criteria:

A Pass - Normal operation, no effect.

B Pass - Temporary degradation, self recoverable.

C Pass - Temporary degradation, operator intervention required.

D Fail - Not recoverable, component damage.

N/A – Not applicable

Notes:

Regulatory Information for Canada

ICES/NMB-001:2004

This ISM device complies with Canadian ICES-001.

Cet appareil ISM est conforme à la norme NMB-001 du Canada.

Regulatory Information for Australia/New Zealand

This ISM device complies with Australian/New Zealand AS/NZS CISPR11:2004

 **N10149**

Contents

Notices	ii
Certification	iii
Limitation of Warranty	iii
Exclusive Remedies	iii
Safety Summary	iv
Safety Notices	iv
Safety Symbols	v
Regulatory Markings	vi
Waste Electrical and Electronic Equipment (WEEE) Directive 2002/96/EC	vii
General Safety Information	viii
Environmental Conditions	ix

1 Getting Started

Introduction	2
Power Sensor Overview	3
• LED Indicator Guide	4
Principles of Operation	6
The U2000 Series USB Power Sensors in Detail	9
Initial Inspection	11
• Package Contents Checklist	11
Hardware Installation and Configuration	12
• System Requirements	12
• Installing Your U2000 Series USB Power Sensor	13
• Verifying Your Connected Power Sensor	16
• Configuring Your Power Sensor via Power Analysis Manager	18
Checking the Power Sensor Firmware	19
• Agilent IO Libraries Suite 15.5	19
• Agilent N1918A Power Analysis Manager	20

2 Operating Information

- Measurement Mode 22
 - Average only Mode 22
 - Normal Mode 22
- Power Sensor Configuration Settings 25
- Measurement Accuracy and Speed 27
 - Setting the Range 27
 - Measurement Considerations 28
- Internal and External Zeroing 30
- Power Sweep and Frequency Sweep 32
- Step Detection 33
- Pulse Power Measurement in Average only Mode 34

3 Specifications and Characteristics

- Introduction 36
- Specifications 38
 - Frequency and Power Ranges 38
 - Connector Type 38
 - Maximum SWR (25 °C ±10 °C) 39
 - SWR Plots for U2000 Series USB Power Sensors 40
 - Maximum SWR (0 °C to 55 °C) 45
 - Maximum Power 47
 - Power Accuracy 48
 - Switching Point 51
 - Zero Set, Zero Drift, and Measurement Noise 53
 - Settling time 59
 - Calibration Factor and Reflection Coefficient 61
 - Cal Factor Uncertainty 62
 - Trigger 65
 - Normal Mode Key Specifications and Characteristics 66
- General Characteristics 67

4 Service

General Information 70

- Cleaning 70
- Connector Cleaning 70

Performance Test 71

- Standing Wave Ratio (SWR) and Reflection Coefficient (Rho) Performance Test 71

Replaceable Parts 74

Service 76

Troubleshooting 76

Repairing a Defective Sensor 76

Disassembly and Reassembly Procedure 77

Attenuator Disassembly and Reassembly Procedure for U2000B and U2001B 79

5 Appendix

Appendix A: Zero Set, Zero Drift, and Measurement Noise 82

List of Figures

- Figure 1-1 LED indicator sequence during power-up 5
- Figure 1-2 Block diagram of the RF/microwave USB power sensor 8
- Figure 1-3 Simplified block diagram of diode pair/attenuator/diode pair 9
- Figure 1-4 Found New Hardware Wizard window 13
- Figure 1-5 Found New Hardware Wizard driver installation 14
- Figure 1-6 Hardware installation warning message 14
- Figure 1-7 Completing hardware driver installations 15
- Figure 1-8 USB device alias configuration 15
- Figure 1-9 Agilent Connection Expert with a list of instrument I/O on the PC 16
- Figure 1-10 Agilent Interactive IO dialog box 16
- Figure 1-11 Identification of your connected power sensor displayed 17
- Figure 1-12 Agilent IO Libraries Suite 19
- Figure 1-13 Power Analysis Manager Instrument Properties panel 20
- Figure 1-14 Calibration due date display 20
- Figure 2-1 Example of trace graph display for GSM signal 23
- Figure 2-2 Measurement gate 24
- Figure 2-3 Auto-averaging settings 26
- Figure 2-4 Select either INT or EXT from the Zero Type option 31
- Figure 3-1 U2000A Typical SWR (25 °C ±10 °C) 40
- Figure 3-2 U2001A Typical SWR (25 °C ±10 °C) 41
- Figure 3-3 U2002A Typical SWR (25 °C ±10 °C) 41
- Figure 3-4 U2004A Typical SWR (25 °C ±10 °C) 42
- Figure 3-5 U2000H Typical SWR (25 °C ±10 °C) 42
- Figure 3-6 U2001H Typical SWR (25 °C ±10 °C) 43
- Figure 3-7 U2002H Typical SWR (25 °C ±10 °C) 43
- Figure 3-8 U2000B Typical SWR (25 °C ±10 °C) 44
- Figure 3-9 U2001B Typical SWR (25 °C ±10 °C) 44
- Figure 3-10 Typical power accuracy at 25 °C for U2000/1/2/4A models 49
- Figure 3-11 Typical power accuracy at 25 °C for U2000/1B models 49
- Figure 3-12 Typical power accuracy at 25 °C for U2000/1/2H models 50
- Figure 3-13 Settling time with auto filter, default resolution, and a 10 dB decreasing power step (not across the switching point) 60

List of Tables

Table 1-1 States of LED indicator and its description	4
Table 2-1 Sensor Ranges	27
Table 2-2 Range Crossover Values	28
Table 3-1 Average only Mode Power Accuracy (with exclusions)	48
Table 3-2 Normal Mode Power Accuracy (with exclusions)	48
Table 3-3 Switching point	51
Table 3-4 Noise Multiplier for Average only Mode	55
Table 3-5 Settling Time for Normal and x2 Speed	59
Table 4-1 Power Sensor SWR and Reflection Coefficient for the U2000A	71
Table 4-2 Power Sensor SWR and Reflection Coefficient for the U2001A	71
Table 4-3 Power Sensor SWR and Reflection Coefficient for the U2002A	72
Table 4-4 Power Sensor SWR and Reflection Coefficient for the U2004A	72
Table 4-5 Power Sensor SWR and Reflection Coefficient for the U2000H	72
Table 4-6 Power Sensor SWR and Reflection Coefficient for the U2001H	73
Table 4-7 Power Sensor SWR and Reflection Coefficient for the U2002H	73
Table 4-8 Power Sensor SWR and Reflection Coefficient for the U2000B	73
Table 4-9 Power Sensor SWR and Reflection Coefficient for the U2001B	73
Table 4-10 Replaceable Parts	75
Table 4-11 Disassembly Procedure	77
Table 4-12 Attenuator Disassembly Procedure	79
Table 4-13 Attenuator Reassembly Procedure	80
Table 5-1 Zero Set, Zero Drift, and Measurement Noise for Average only Mode	82

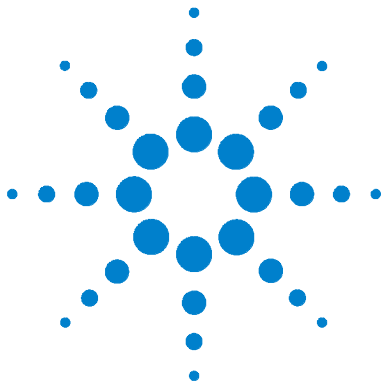

1 Getting Started

Introduction	2
Power Sensor Overview	3
Principles of Operation	6
The U2000 Series USB Power Sensors in Detail	9
Initial Inspection	11
Hardware Installation and Configuration	12
Checking the Power Sensor Firmware	19

This chapter introduces the Agilent U2000 Series USB power sensors with detailed information on the principles of operation, initial inspection, hardware installation and configuration, and a brief introduction of the Agilent N1918A Power Analysis Manager.



Introduction

The Agilent U2000 Series USB power sensors are standalone power sensors used for measuring the average power of continuous wave (CW) and modulated signals in 9 GHz to 24 GHz frequency range and -60 dBm to $+44$ dBm power range. The power sensors provide an easy plug-and-play USB connectivity to a PC or laptop, thus eliminating the need for a separate conventional power meter. The power sensors also compatible with some selected USB-based instruments from Agilent.

The figure below shows the Agilent U2000 Series USB power sensors family.



Power Sensor Overview

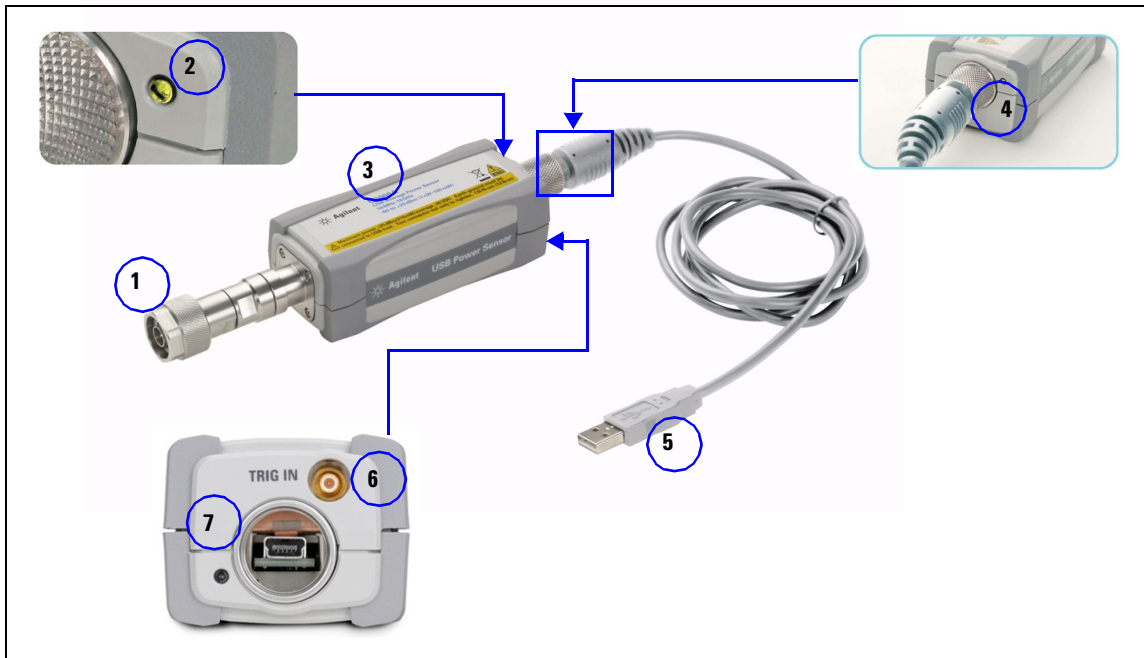

No.	Part	Functions
1	RF input port	Allows RF/microwave input signal
2	LED indicator	Indicates the states of the power sensor. Refer to “LED Indicator Guide” for more information.
3	Sensor body	Contains the core components of the power sensor
4	Physical lock mechanism	Enables secure locking mechanism
5	USB compliant cable	Connects the power sensor to the PC or other instruments
6	External trigger port	Enables synchronization with external instruments or events
7	USB port	Enables USB connectivity

LED Indicator Guide

The LED indicator is found at the rear panel of the power sensor. The following table shows the states of the LED indicator and its description.

Table 1-1 States of LED indicator and its description

LED indicator	Description
GREEN blinking	Device in communication mode. Example: Sending SCPI commands or reading data.
RED blinking	Error - Highest priority event The error is due to HW/OS/Self-test. All other LED indicators will not function while having this error. The error message can be read by sending SYST:ERR? command. Users are advised to return the power sensor to Agilent.
RED	Error. Use SYST:ERR? to read the error message. Reading the error message will also clear the LED indication. Users are advised to read the message as some of the error might cause measurement errors. Example of error cause: 1 SCPI command syntax error 2 Invalid Zero
AMBER	Zeroing is in progress. Sending SCPI commands during the zeroing process will cause error. This will cause the LED indicator to turn RED.

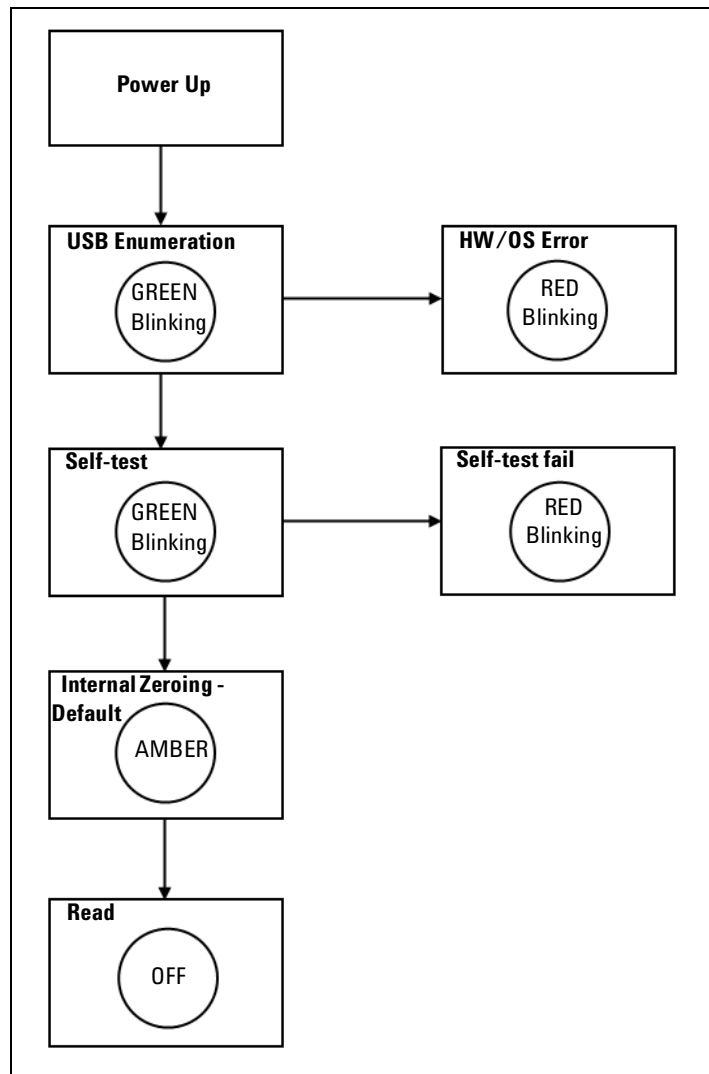

Figure 1-1 LED indicator sequence during power-up

Principles of Operation

The U2000 Series USB power sensors function as a power meter and power sensor in one device. The power sensor has the capability of sensing the signal, acquiring the data and signal conditioning, processing the data, and fulfilling communication function as in other Agilent test instruments.

The low power measurement path is a 2-diode stacks and the high power path contains 5-diode stacks which extend the dynamic range square-law detection. The range selection is performed automatically by the U2000 Series based on the measured power levels. The sensing element technology has been previously used in the popular E9300 Series power sensors. The new U2000 Series includes all the signal conditioning and analog-to-digital formatting functions that have been in use for several years. Thus, you can be assured that the U2000 Series USB power sensors will deliver highly predictable results.¹

The main component for the sensing element of the U2000 Series is the RF input port assembly which provides a 50 Ω load to the RF signal applied to the power sensor. A dual range GaAs diode pair/attenuator/diode pair assembly in the RF input port rectifies the applied RF signal to produce dc voltages (high and low ranges) which vary with the RF power across the 50 Ω load. Thus, the voltage varies with the RF power dissipated in the load.

The low-level dc voltage from the RF input port assembly is picked up by the signal conditioning part of the sensor which consists of high isolation switches, chopper circuitry, and high gain amplifier. Differential electronics is maintained from the sensing element up to the 14-bit Analog-to-Digital Converter (ADC) for signal integrity and noise immunity. Amplification and signal conditioning assure that drift and gain stability are not compromised before hitting the high performance 14-bit ADC modules. From there, the digitized power data enters the processor which operates as an on-board computer for the self-contained sensor.

1 Agilent Fundamentals of RF and Microwave Power Measurements (Part 2), Power Sensors and Instrumentation, Literature Number 5988-9214EN

Anderson, Alan B., October, 2000, Measuring Power Levels in Modern Communication Systems, MW/RF Magazine

Sensor control and processing is provided by an embedded processor with Digital Signal Processing (DSP) capability which is supported by a 64 MB SDRAM. The available processing power enables the implementation of correction algorithm such as linearity correction, calibration factor, temperature compensation algorithm and internal zeroing algorithm. The correction factors for the sensors are stored in a 3 MB Flash memory. In the temperature compensation algorithm and internal zeroing algorithm implementation, the processor continuously monitors sensor temperatures using a thermistor which is located in the vicinity of the diode sensing element as shown in [Figure 1-3](#). The trigger input port which is based on TTL enables the sensor to synchronize with events. The U2000 Series supports high data rate transfer of 480 Mb/s through the Universal Serial Bus (USB) connectivity which is USB-TMC compliance.

External zeroing is performed similar to other power sensors - the RF power is removed from the sensor by the user and then the sensor is zeroed. Internal zeroing is a new type of zeroing whereby the RF power can be left connected to the sensor while it is being zeroed. The power sensor will remove the RF power from the diode sensor internally in the sensor.

During the external zeroing process, the data from the front end circuitry which includes the RF diode sensing element, signal conditioning, and data acquisition circuit will be acquired. The zero information is then used. Do not apply any RF/microwave signals to the bulkhead during external zeroing process. Any RF/microwave signals pick-up by the diode sensor during the external zeroing will be considered as part of the noise.

During internal zeroing process, high isolation switches are opened in the sensor to isolate the diode sensor from the electronic circuitry. With the available processing power from the embedded DSP in the power sensor, the internal zeroing algorithm is applied to the internal zero data. The internal zeroing process simplifies the product operation by removing the circuitry noise without requiring the RF signal to be removed from the power sensor. Hence, internal zeroing is able to provide the convenience of performing a zero with the RF/microwave signal present.

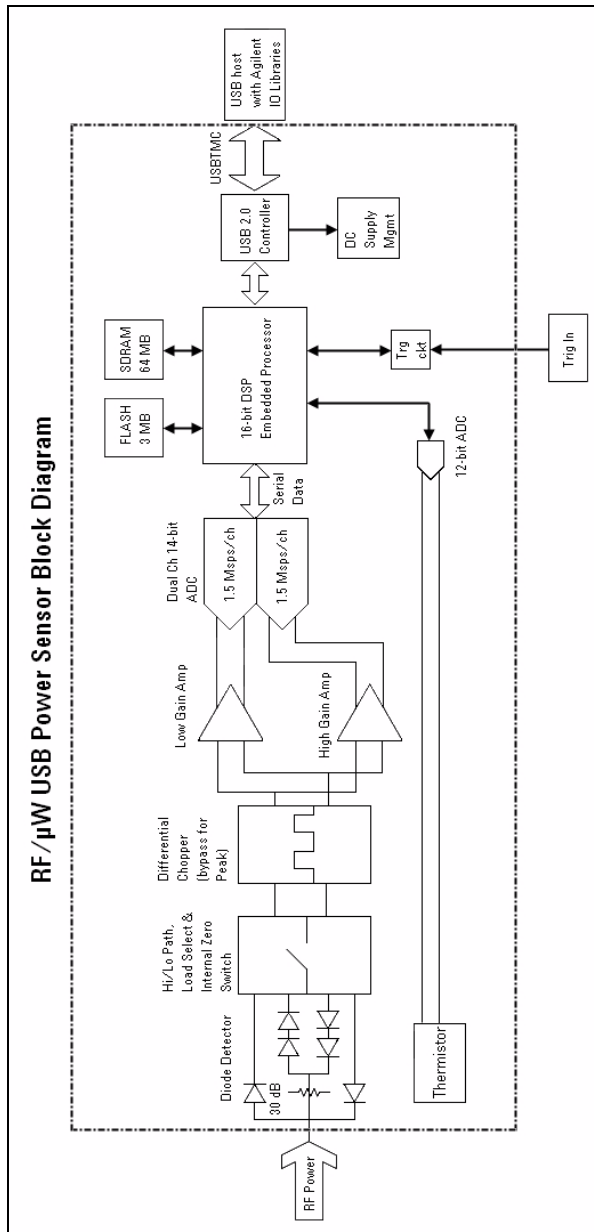

Figure 1-2 Block diagram of the RF/microwave USB power sensor

The U2000 Series USB Power Sensors in Detail

Most of the power sensors used for measuring average power employ either thermocouple or diode technology. Diode-based sensors frequently rely on the application of correction factors to extend their dynamic range beyond their square law response region, typically from -70 dBm to -20 dBm. While this technique achieves a wide dynamic range capability, however, it is limited to continuous wave (CW) signals outside the square law region. Modulated signals must be padded down or at low levels, with their average and peak power levels within the diode square law region, to be measured accurately. Accurate average power measurement of high-level signals carrying modulation cannot be obtained using a CW correction factor technique. Specialized modulation sensors are able to provide accurate measurements but are limited by the bandwidth.

The U2000 Series USB power sensors are true average, wide dynamic range RF/microwave power sensors. They are based on a dual sensor diode pair/ attenuator/diode pair as proposed by Szente et. al. in 1990¹. Figure 1-3 shows a block diagram of this technique.

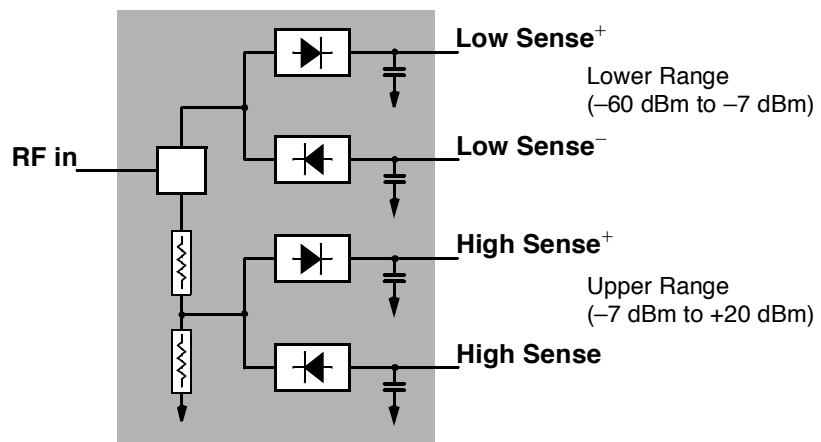

Figure 1-3 Simplified block diagram of diode pair/attenuator/diode pair

¹ US Patent #4943764, assigned to Hewlett-Packard Company

This technique will ensure the diodes in the selected signal path are kept in their square law region, thus the output current (and voltage) is proportional to the input power. The diode pair/attenuator/diode pair assembly can yield the average of complex modulation formats across a wide dynamic range, irrespective of the signal bandwidth. The dual range Modified Barrier Integrated Diode (MBID)¹ package includes further refinements to improve power handling allowing accurate measurement of high level signals with high crest factors without incurring damage² to the sensor.

These sensors measure average RF power on a wide variety of modulated signals and are independent of the modulation bandwidth. They are ideally suited to the average power measurement of multi-tone and spread spectrum signals such as CDMA, W-CDMA, and digital television formats.

1 November 1986 Hewlett-Packard Journal pages 14-2, "Diode Integrated Circuits for Millimeter-Wave Applications.

2 Refer to "[Maximum Power](#)" on page 47 for maximum power handling specifications.

Initial Inspection

Inspect the shipping container for damages. If the shipping container or packaging material is damaged, it should be kept until the contents of the shipment have been checked mechanically and electrically. If there is any mechanical damage, notify the nearest Agilent Technologies office. Keep the damaged shipping materials (if any) for inspection by the carrier and a Agilent Technologies representative. If required, you can find a list of Agilent Technologies Sales and Service offices on the last page of the guide.

Package Contents Checklist

Inspect and verify the following items for the standard purchase of the U2000 Series USB power sensors. If there are missing items, contact the nearest Agilent Sales Office.

- Trigger cable BNC Male to SMB female 50 Ω , 1.5 m
- Power sensor cable, 1.5 m
- U2000 Series USB Power Sensor Programming Guide
- U2000 Series USB Power Sensor Operating and Service Guide (English)
- Certificate of Calibration
- U2000 Series USB Power Sensor Documentation CD
- N1918A Power Analysis Manager Assembly
- Agilent Automation-Ready CD (contains Agilent IO Libraries Suite)

Hardware Installation and Configuration

System Requirements

Prior to using the U2000 Series USB power sensors, please ensure that the following minimum requirements are met:

- PC or any device that has USB host capability
- Agilent IO Libraries Suite 15.5 or higher had been installed. Users are encouraged to obtain the latest version of Agilent Libraries Suite for better performance.
- *Optional:* Agilent N1918A Power Analysis Manager had been installed (Basic Power Panel is bundled with the purchase of the U2000 Series USB power sensors, while users can also obtain the advanced Power Analyzer which is an optional licensed software with additional features and capabilities)¹.
- The U2000 Series can also be programmed using remote programming software such as Agilent VEE, LabVIEW®, and Microsoft® Visual Basics

¹ Refer to the *N1918A Power Analysis Manager Data Sheet*, 5989-6612EN for more information on the features of the Power Panel and Power Analyzer.

Installing Your U2000 Series USB Power Sensor

U2000 Series offers USB plug-and-play capability, with the proficiency of power meter and power sensor in a unit that enables users to obtain measurement readings via N1918A Power Analysis Manager.

Follow the instructions below to install and configure the U2000 Series.

- 1 Connect your U2000 Series USB power sensor to the PC using the USB cable provided. Connect the cable's mini-B plug to your power sensor and the other end of the cable (type-A plug) to any USB host on your PC.
- 2 The PC will automatically detect the connected power sensor and the Found New Hardware Wizard window will appear as shown below.



Figure 1-4 Found New Hardware Wizard window

- 3 Select **Yes, this time only** and click **Next** to proceed.
- 4 On the following window, select **Install the software automatically (Recommended)** and click **Next**.

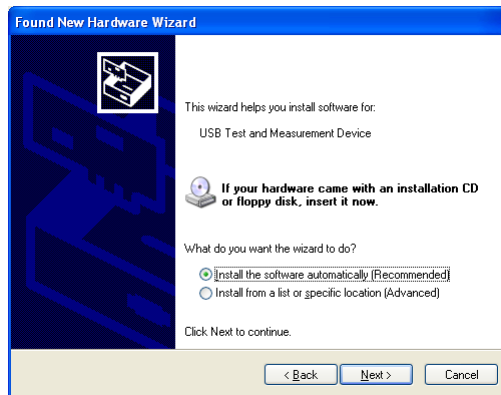

Figure 1-5 Found New Hardware Wizard driver installation

- 5 A warning message will appear in the Hardware Installation window, as shown below. Click **Continue Anyway** to proceed with the installation of the driver.



Figure 1-6 Hardware installation warning message

NOTE

If you do not wish to receive similar warning message in future, follow the instructions below.

- 1 Go to **Start > Control Panel** and double-click **System**.
- 2 Select **Hardware** tab, on the Drivers panel click **Driver Signing** and the Driver Signing Options dialog box will appear.
- 3 Select **Ignore** to disable the warning message.

- 6 Click **Finish** when the installation has completed.



Figure 1-7 Completing hardware driver installations

- 7 Once the driver installation has completed, the Assign USB device alias window may appear as shown below. Each time a USB device is plugged in, this dialog will be shown. To configure or disable this dialog, select an options in the **Show this dialog** panel and click **OK**.

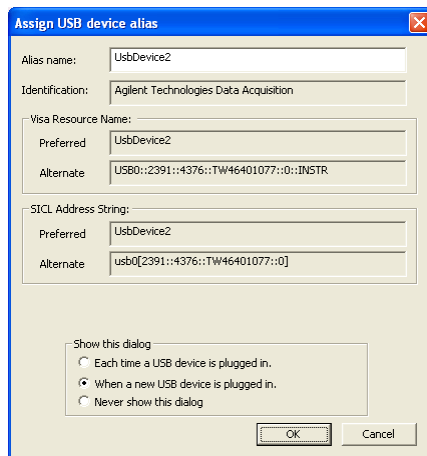

Figure 1-8 USB device alias configuration

Verifying Your Connected Power Sensor

- 1 To verify your connected power sensor, go to **Start > All Programs > Agilent IO Libraries Suite > Agilent Connection Expert** to launch Agilent Connection Expert.
- 2 Your connected power sensor will be detected and shown on the **Instrument I/O on this PC** panel as shown in the following figure.

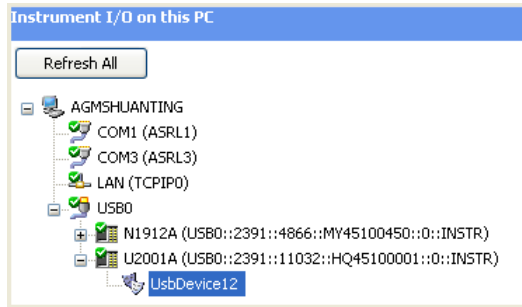

Figure 1-9 Agilent Connection Expert with a list of instrument I/O on the PC

- 3 Select the U2000 USB sensor on the list of USB device connected to the PC and right-click. A context menu will appear and select **Send Command To This Instrument** and the Agilent Interactive IO dialog box will appear as shown below.

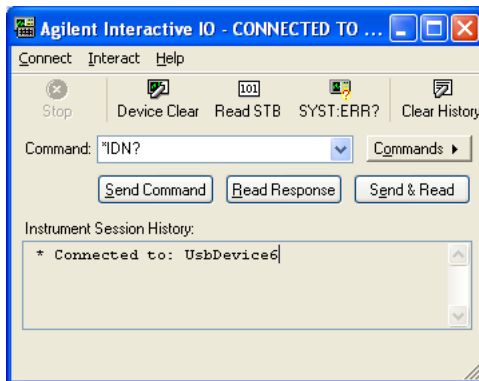

Figure 1-10 Agilent Interactive IO dialog box

- To verify your connected power sensor, send the default SCPI command `*IDN?` to the power sensor by clicking **Send & Read**. The device's response will appear in the **Instrument Session History** panel as shown in the following figure.

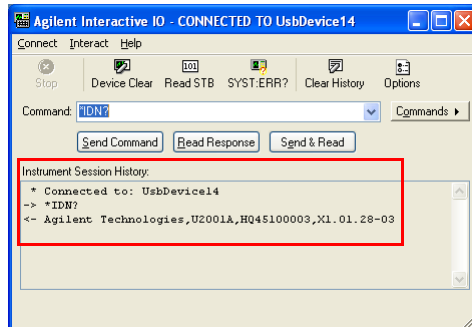

Figure 1-11 Identification of your connected power sensor displayed

- This verify that your U2000 Series USB power sensor has been connected and properly installed on your PC.

Configuring Your Power Sensor via Power Analysis Manager

- 1 Go to **Start > All Programs > Agilent N1918A Power Analysis Manager > Advance > Power Analyzer** to launch your Power Analysis Manager.
- 2 With your power sensor still connected, a pop-up reminder dialog will appear when you launch the Power Analysis Manager. The reminder message will appear under two conditions:
 - a You have not set any calibration due date for your U2000 Series. The reminder prompts you to set your calibration due date.
 - b Your calibration date is due and the reminder prompts you to send your U2000 Series for calibration.
- 3 Click **OK** and you may proceed to set the calibration due date or connect a new power sensor to proceed.
- 4 To set the calibration due date, go to Instrument Panel, in the System tab, input the due date of your calibration in the Cal Due Date property.

NOTE

For remote interface configurations of P-Series power meters, refer to **Remote Interface Configurations** in *Agilent P-Series Power Meters Installation Guide* and for remote interface configuration of N8262A P-Series modular power meters, refer to *N8262A P-Series Modular Power Meters Installation Guide*.

Checking the Power Sensor Firmware

There are two ways that can be used to check the firmware revision of the power sensor:

Agilent IO Libraries Suite 15.5

By using the Agilent IO Libraries Suite version 15.5 or higher, you can check the model code, serial number, firmware revision, and USB address. The VISA address is the USB address (see below).

VISA address: USB0::2391::11544::MY47400105::0::INSTR

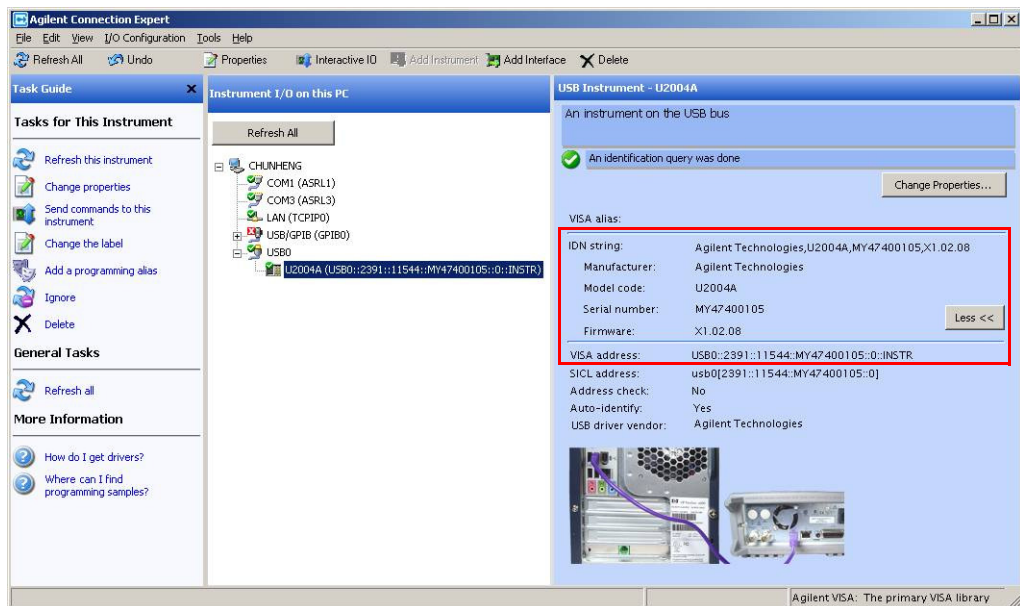

Figure 1-12 Agilent IO Libraries Suite

Agilent N1918A Power Analysis Manager

By using the N1918A Power Analysis Manager, you can check the description, firmware revision, model number, resource ID and serial number as shown below:

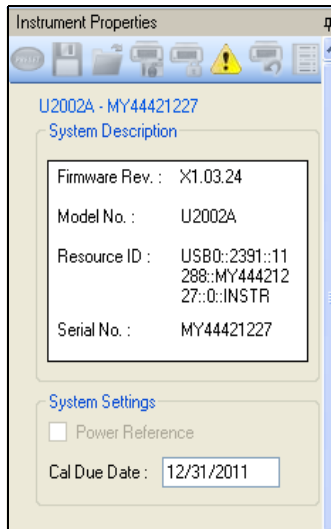

Figure 1-13 Power Analysis Manager Instrument Properties panel

It is advisable to set the calibration due date. Refer to [page 18](#) for more details.

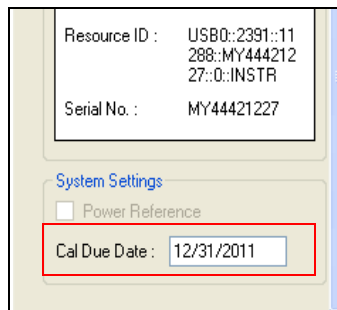

Figure 1-14 Calibration due date display



2 Operating Information

Measurement Mode	22
Power Sensor Configuration Settings	25
Measurement Accuracy and Speed	27
Internal and External Zeroing	30
Power Sweep and Frequency Sweep	32
Step Detection	33
Pulse Power Measurement in Average only Mode	34

This chapter describes some general operating information of the U2000 Series USB power sensors.



Measurement Mode

The U2000 Series USB power sensors have two measurement modes: average only (chopper-based measurement) and normal¹ (sample-based measurement) mode.

Average only Mode

The average only mode (default mode) is optimized for wide dynamic range. In this measurement mode, a trigger can be controlled externally via TTL input.

Normal Mode

The normal mode is used for making average power measurement in a defined time interval (also known as time-gated measurement) with reduced dynamic range. A trigger can be derived from an RF signal (internal trigger) or controlled externally via TTL input (external trigger).

Trace Display

The U2000 Series USB power sensors can also be configured to display measurement results in trace format using SCPI commands or the N1918A Power Analysis Manager when the power sensors are set to normal mode.

To create the trace graph display using SCPI commands, refer to the programming example available in the *Agilent U2000 Series USB Power Sensors Programming Guide*.

To set up the trace graph display using the N1918A Power Analysis Manager, refer to the software help file for a step-by-step procedure.

[Figure 2-1](#) shows the illustration of the trace graph if the N1918A Power Panel tool is used.

¹ Not applicable for U2004A.

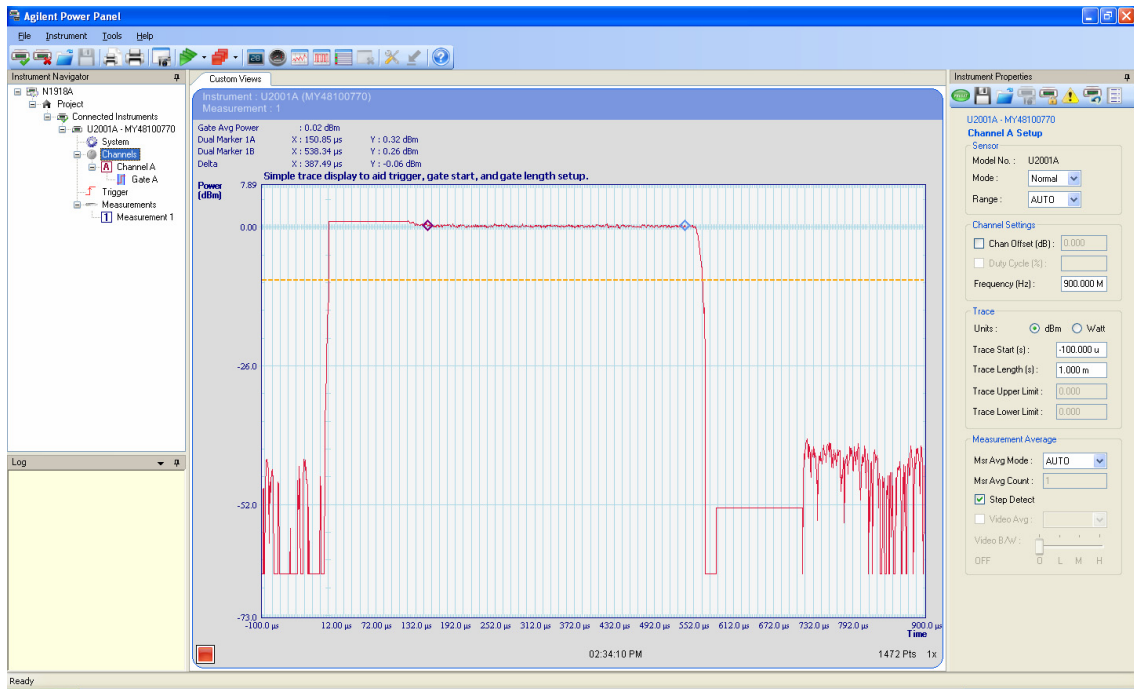

Figure 2-1 Example of trace graph display for GSM signal

Measurement Gate

A gate, controlled by and referenced to a trigger point, is used to extract measurement data from the captured trace. You can measure the gated average power of pulsed signals with the gate setup as shown in [Figure 2-2](#) on page 24.

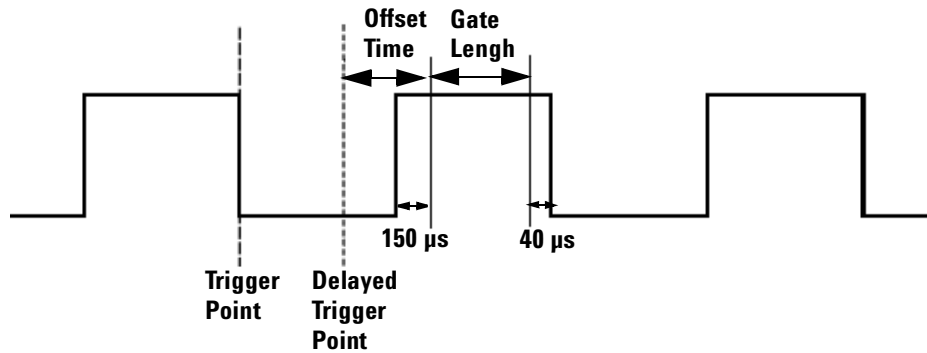

Figure 2-2 Measurement gate

NOTE

It is strongly recommended for the gate to have 150 μs (range settling time) offset from the pulse rising edge and 40 μs (fall time) offset from the pulse falling edge to achieve higher accuracy measurements. Samples collected during range settling time are discarded. Thus, fewer samples are used for generating a measurement.

Power Sensor Configuration Settings

The auto-averaging settings shown in [Figure 2-3](#) are automatically configured when the U2000 Series USB power sensors are connected.

NOTE

Averaging settings can also be manually configured.

In [Figure 2-3](#), the dotted-line arrow  indicates the internal range based on the internal circuitry of the power sensor. The ranges will be automatically selected in correspondence with the power level to best fit the operating conditions and settings.

	Expected Power			Maximum Sensor Power Within a Range	Resolution Setting			
	U2000/1B	U2000/1/2H	U2000/1/2/4A		1	2	3	4
Sensor Dynamic Range	High Power Path	44 dBm	30 dBm	20 dBm	1	1	1	1
		35 dBm	25 dBm	15 dBm	1	1	1	128
		26 dBm	20 dBm	10 dBm	1	1	1	512
		28 dBm	25 dBm	15 dBm	1	1	1	1
		24 dBm	15 dBm	5 dBm	1	1	1	1024
		22.5 dBm	6 dBm	-4 dBm	1	1	256	1024
		23.5 dBm	8 dBm	-2 dBm	1	1	1	1024
		18 dBm	4 dBm	-6 dBm	1	1	128	1024
		10 dBm	2.5 dBm	-7.5 dBm	1	1	512	1024
		15 dBm	3.5 dBm	-6.5 dBm	1	1	1	1
	Low Power Path	7 dBm	-2 dBm	-12 dBm	1	1	1	1024
		-3 dBm	-10 dBm	-20 dBm	1	1	16	1024
		-8 dBm	-5 dBm	-15 dBm	1	1	1	1
		-5 dBm	-13 dBm	-23 dBm	1	1	1	1024
		-8 dBm	-23 dBm	-33 dBm	1	1	256	1024
		-5 dBm	-28 dBm	-38 dBm	1	1	512	1024
		-8 dBm	-25 dBm	-35 dBm	1	1	16	1024
		-15 dBm	-28 dBm	-38 dBm	1	1	1024	1024
		-25 dBm	-35 dBm	-45 dBm	1	1024	1024	1024
		-30 dBm	-45 dBm	-55 dBm	128	1024	1024	1024
	-50 dBm	-60 dBm	512	1024	1024	1024		
			Minimum Sensor Power Within a Range					

Figure 2-3 Auto-averaging settings

Measurement Accuracy and Speed

With U2000 Series USB power sensors, the range can be set either automatically or manually. Use auto-ranging when you are not sure of the power level you are about to measure.

The DC coupling of the U2004A USB power sensor input allows excellent low frequency coverage. However, the presence of any DC voltages mixed with the signal will have an adverse effect on the accuracy of the power measurement, see [on Page 51](#).

CAUTION

To prevent damage to your sensor, do not exceed the power levels specified in the section “[Maximum Power](#)” on page 47.

The U2004A USB Power Sensor is DC coupled. DC voltages in excess of the maximum value (5 VDC) can damage the sensing diode.

Setting the Range

There are two manual settings, “LOWER” and “UPPER”. The LOWER range uses the more sensitive path and the UPPER range uses the attenuated path in the U2000 Series USB power sensors (see [Table 2-1](#)).

Table 2-1 Sensor Ranges

Sensor	LOWER range	UPPER range
U2000A, U2001A, U2002A, U2004A	-60 dBm to -7 dBm	-7 dBm to +20 dBm
U2000H, U2001H, U2002H	-50 dBm to +3 dBm	+3 dBm to +30 dBm
U2000B, U2001B	-30 dBm to +23 dBm	+23 dBm to +44 dBm

The default is “AUTO”. In AUTO the range crossover value depends on the sensor model being used (see [Table 2-2](#)).

Table 2-2 Range Crossover Values

Sensor	Range Crossover Values
U2000A, U2001A, U2002A, U2004A	-7 dBm \pm 1 dB
U2000H, U2001H, U2002H	+3 dBm \pm 1 dB
U2000B, U2001B	+23 dBm \pm 1 dB

Measurement Considerations

While auto-ranging is a good starting point, it is not ideal for all measurements. Signal conditions such as crest factor or duty cycle may cause the power sensor to select a range which is not the optimum configuration for your specific measurement needs. Signals with average power levels close to the range switch point require you to consider your needs for measurement accuracy and speed.

For example, a U2000/1/4A sensor, where the range switch point is -7 ± 1 dBm in a pulsed signal, should be configured as follows:

Characteristic	Value
Peak Amplitude	-6 dBm
Duty Cycle	25%

The calculated average power is -12 dBm.

Accuracy

The value of -12 dBm lies in the lower range of the U2000/1/4A sensor. In auto-ranging mode (“AUTO”), the U2000/1/4A sensor determines the average power level is below -7 dBm and selects the low power path. However, the peak amplitude of -6 dBm is beyond the specified square law response range of the low power path diodes. The high power path (-7 dBm to +20 dBm) should be used to ensure a more accurate

measurement of this signal. However, range holding in “UPPER” (the high power path), for a more accurate measurement, results in a considerably increased number of filtering processes.

Speed and Averaging

The same signal also requires a specific consideration of the measurement speed. As shown above, in auto-ranging mode, the U2000/1/4A sensor determines the average power level is below -7 dBm and selects the low power path. With auto-averaging configured, minimal filtering is applied. Values of one to four for average power levels above -20 dBm are used in the low power path. (Refer to “[Auto-averaging settings](#)” on page 26.)

If the range is held in “UPPER” for more accuracy, the measurement is slower. More filtering is applied due to the increase in noise susceptibility at the less sensitive area of the high power path. Values of one to 128 for average power levels less than -7 dBm are used. (Again, refer to “[Auto-averaging settings](#)” on page 26.) Manually lowering the filter settings speeds up the measurement but can result in an unwanted level of jitter.

Summary

Attention must be paid to signals where the average power levels are in the low power path range while the peaks are in the high power path range. You can achieve best accuracy by selecting the high power path or achieve best speed by selecting the low power path.

Internal and External Zeroing

Zeroing a power sensor is performed in order to reduce zero measurement offset and noise impact to improve the accuracy of RF power measurement. The U2000 Series USB power sensors have two types of zeroing; internal zeroing and external zeroing.

Internal zeroing is a new type of zeroing process whereby RF/Microwave power can be left connected to the sensor while it is being zeroed. High isolation switches are opened in the sensor to isolate the diode sensor from the electronic circuitry. With the available processing power from the embedded DSP in the sensor, the internal zeroing algorithm is applied to the internal zeroing data. Hence, internal zeroing provides the convenience of performing a zero with the RF/microwave signal present. This feature makes internal zeroing more convenient, but one may only use internal zeroing if zero set (internal) is within the user's application requirements.

External zeroing process is a two-step process. The RF/Microwave signal to be measured must be removed from the sensor and then the sensor can be zeroed. Do not apply any RF/microwave signals to the RF input port during external zeroing process. Any RF/microwave signals pick-up by the diode sensor during external zeroing will be considered as part of the noise. External zeroing generally has better zero set performance. The internal or external zeroing selection should be made based on the measurement needs.

Users can choose to use either internal zeroing or external zeroing. The sensor is defaulted with internal zero every time it is powered up. [Figure 2-4](#) shows the illustration on how to set the external zeroing if the N1918A Power Panel tool is used.

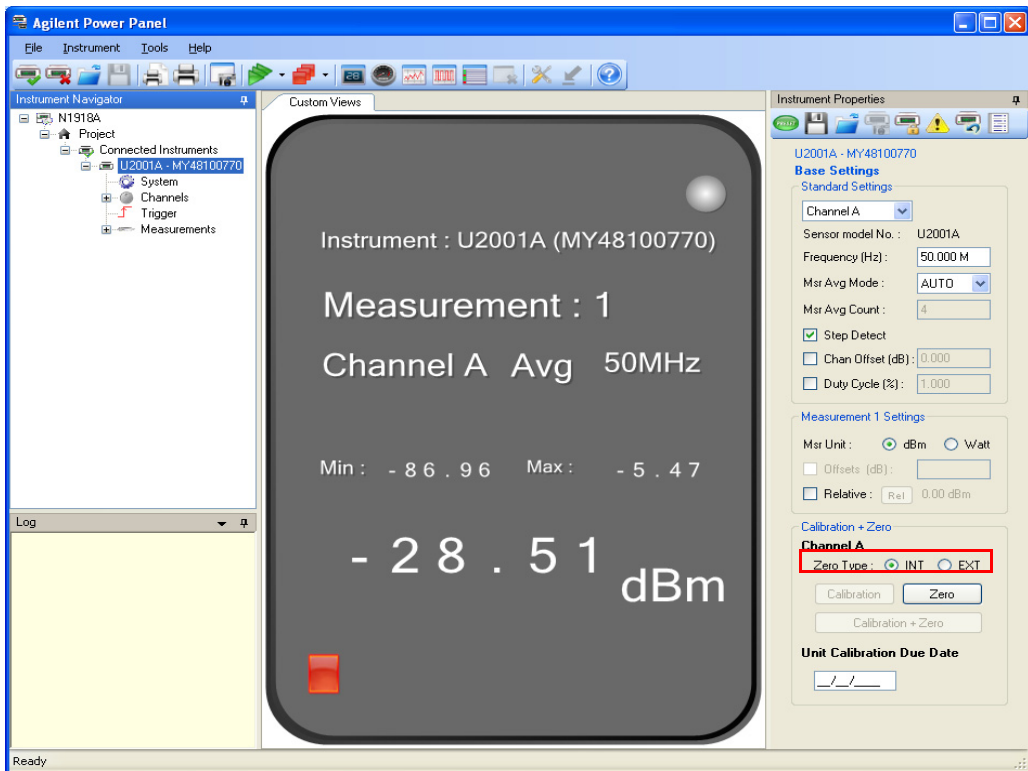

Figure 2-4 Select either INT or EXT from the Zero Type option

Power Sweep and Frequency Sweep

The frequency sweep and power sweep features provide measurement automation between the U2000 Series USB power sensor and the signal source. This feature reduces the communication path and improves test time by eliminating the need of PC-instrument communication.

To perform frequency sweep operation, users are required to set the start frequency, stop frequency and number of step for the signal source. By default, the step value is set to 0. The number of step ranges from 0 to 2048.

Connect the signal source TRIG OUT to the power sensor TRIG IN. Once the sweeping operation starts, the signal source will step through each frequency point within the preset range. Each step will send a TTL signal to the power sensor notifying it to measure the signal power. Only a one-way synchronization occurs in this process which is from the signal source to the power sensor.

A proper dwell time must be set in the signal generator to ensure all the measurement readings in the power sensor are settled before stepping through the next frequency point. The same process is applicable to the power sweep operation.

Step Detection

To reduce the filter settling time after a significant step in the measured power, the filter can be set to re-initialize upon detection of a step increase or decrease in the measured power. Step detection can be set in both manual and automatic filter modes. Refer to the *U2000 Series Programming Guide* for more details on how to enable or disable the step detection.

Pulse Power Measurement in Average only Mode

The U2000 Series USB power sensors provide capability of performing average power measurements of pulsed signals in average only mode with the signal profile as shown below:

- Pulse width $\geq 30 \mu\text{s}$
- Pulse period $\leq 8 \text{ ms}$
- Duty cycle $\geq 1\%$

To perform accurate average power measurements of pulsed signals, preset the sensor to Burst mode or using “SYSTEM:PRESet BURST” SCPI command. It is recommended to disable the step detection and set the average count to ≥ 256 .

The U2000 Series USB power sensors are designed to perform average power measurements over dynamic range of -60 dBm to $+44 \text{ dBm}$. The supported power range for each sensor model is shown as follows:

Model	Power Range
U2000/1/2A	-60 dBm to $+20 \text{ dBm}$
U2000/1/2H	-50 dBm to $+30 \text{ dBm}$
U2000/1B	-30 dBm to $+44 \text{ dBm}$

Regular external zeroing and higher average count are required when the pulsed signal is under one of the following circumstances:

- The pulse power takes place within the last 10 dB of the sensor’s lower dynamic range (for example, -60 dBm to -50 dBm for U2000/1/2A model)
- The pulse width is from $30 \mu\text{s}$ to $40 \mu\text{s}$
- The duty cycle is $< 2\%$

NOTE

The pulse power measurement in average only mode is not applicable for U2004A.



3 Specifications and Characteristics

Introduction	36
Specifications	38
General Characteristics	67

This chapter describes the specifications and characteristics of your U2000 Series USB power sensors.



Introduction

U2000 Series USB power sensors are average, wide dynamic range power sensors that can be used with a PC or some selected USB-based instruments from Agilent. The U2000 Series USB power sensors have two measurement modes:

- **Average only mode** (default mode): chopper-based measurement
- **Normal¹ mode**: sample-based measurement

The specifications contained in this chapter are valid ONLY after proper calibration of the power sensor and apply to continuous wave (CW) signals unless otherwise stated. The recommended calibration interval for this product is 1 year. Specifications apply over a temperature range 0 °C to +55 °C unless otherwise stated.

Specifications quoted over a temperature range of 25 °C ±10 °C apply to a relative humidity of 15% to 75% and conform to the standard environmental test conditions. These specifications are valid after a 30-minute warm-up period.

The dynamic range of the U2000 Series USB power sensors is –60 dBm to +44 dBm and the range is divided into two independent measurement paths – a low power path and a high power path, as shown below:

Sensor	Low Power Path	High Power Path
U2000A, U2001A, U2002A, U2004A	–60 dBm to –7 dBm	–7 dBm to +20 dBm
U2000H, U2001H, U2002H	–50 dBm to +3 dBm	+3 dBm to +30 dBm
U2000B, U2001B	–30 dBm to +23 dBm	+23 dBm to +44 dBm

Some specifications are detailed for individual measurement paths, with the automatic switching point at:

- –7 dBm for U2000/1/2/4A
- +3 dBm for the U2000/1/2H
- +23 dBm for U2000/1B

¹ Not applicable for U2004A.

Supplemental characteristics, which are shown in italics, are intended to provide useful information with regard to applying the power sensors in that they contain typical, but non-warranted performance parameters. These characteristics are shown in *italics* or denoted as “*typical*”, “*nominal*” or “*approximate*”.

Specifications

Frequency and Power Ranges

Model	Frequency Range	Power Range
U2000A	10 MHz to 18.0 GHz	-60 dBm to +20 dBm
U2001A	10 MHz to 6.0 GHz	
U2002A	50 MHz to 24 GHz	
U2004A	9 kHz to 6.0 GHz	
U2000H	10 MHz to 18 GHz	-50 dBm to +30 dBm
U2001H	10 MHz to 6 GHz	
U2002H	50 MHz to 24 GHz	
U2000B	10 MHz to 18 GHz	-30 dBm to +44 dBm
U2001B	10 MHz to 6 GHz	

Connector Type

Model	Connector Type	Impedance
U2000/1/4A	N-Type (m)	50 Ω
U2002A	3.5 mm (m)	50 Ω
U2000/1H	N-Type (m)	50 Ω
U2002H	3.5 mm (m)	50 Ω
U2000/1B	N-Type (m)	50 Ω

Maximum SWR (25 °C ±10 °C)

Model	Frequency	SWR
U2000A	10 MHz to 30 MHz	1.15
	30 MHz to 2 GHz	1.13
	2 GHz to 14 GHz	1.19
	14 GHz to 16 GHz	1.22
	16 GHz to 18 GHz	1.26
U2001A	10 MHz to 30 MHz	1.15
	30 MHz to 2 GHz	1.13
	2 GHz to 6 GHz	1.19
U2002A	50 MHz to 2 GHz	1.13
	2 GHz to 14 GHz	1.19
	14 GHz to 16 GHz	1.22
	16 GHz to 18 GHz	1.26
	18 GHz to 24 GHz	1.30
U2004A	9 kHz to 2 GHz	1.13
	2 GHz to 6 GHz	1.19
U2000B	10 MHz to 2 GHz	1.12
	2 GHz to 12.4 GHz	1.17
	12.4 GHz to 18 GHz	1.24
U2001B	10 MHz to 2 GHz	1.12
	2 GHz to 6 GHz	1.17
U2000H	10 MHz to 8 GHz	1.15
	8 GHz to 12.4 GHz	1.25
	12.4 GHz to 18 GHz	1.28

3 Specifications and Characteristics

U2001H	10 MHz to 6 GHz	1.15
U2002H	50 MHz to 8 GHz	1.15
	8 GHz to 12.4 GHz	1.25
	12.4 GHz to 18 GHz	1.28
	18 GHz to 24 GHz	1.30

SWR Plots for U2000 Series USB Power Sensors

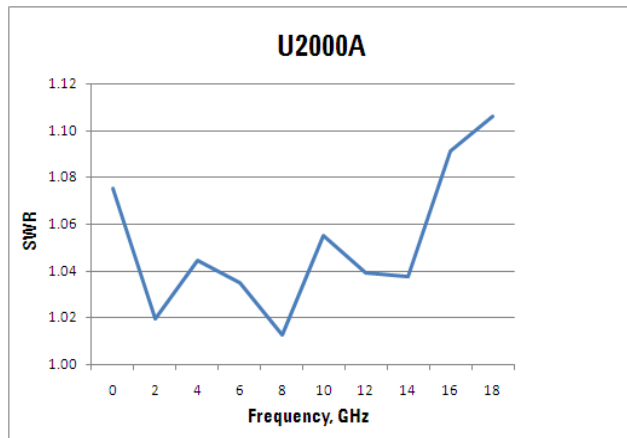

Figure 3-1 U2000A Typical SWR (25 °C ±10 °C)

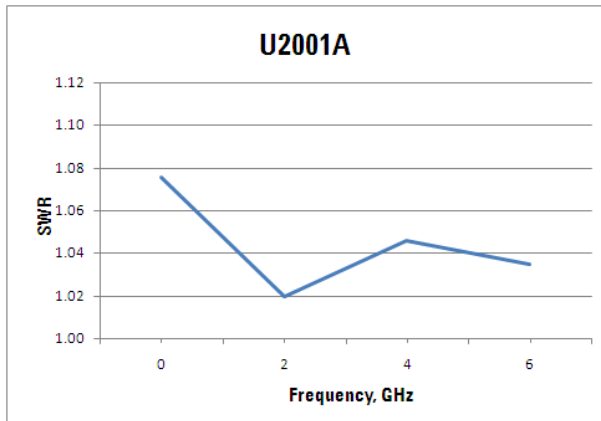

Figure 3-2 U2001A Typical SWR (25 °C ±10 °C)

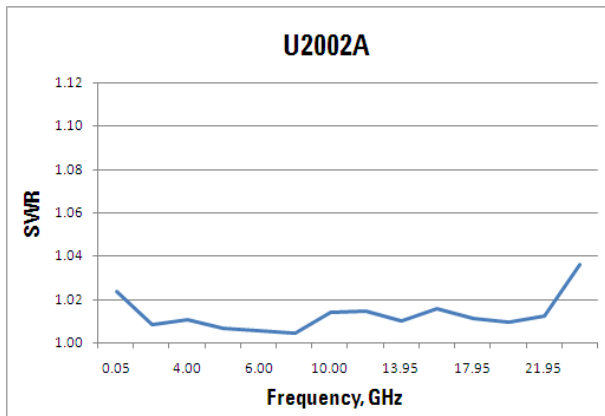

Figure 3-3 U2002A Typical SWR (25 °C ±10 °C)

3 Specifications and Characteristics

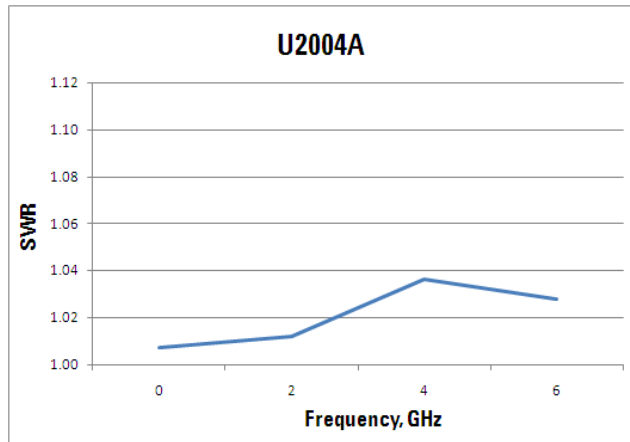

Figure 3-4 U2004A Typical SWR (25 °C ±10 °C)

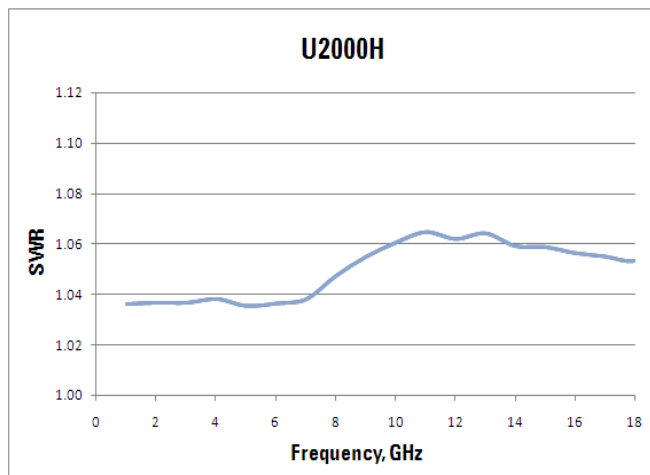

Figure 3-5 U2000H Typical SWR (25 °C ±10 °C)

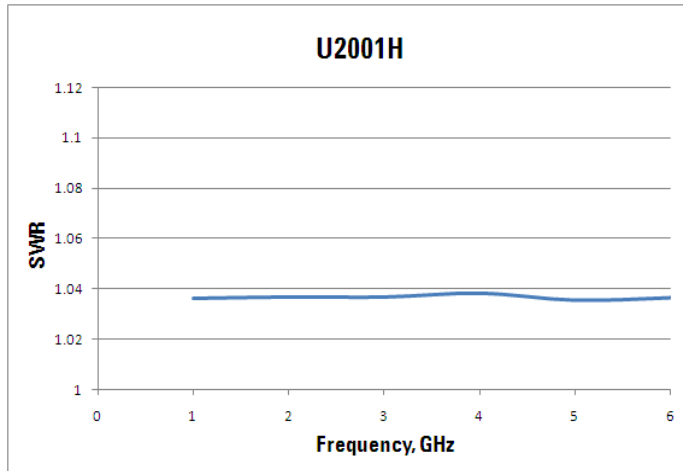

Figure 3-6 U2001H Typical SWR (25 °C ±10 °C)

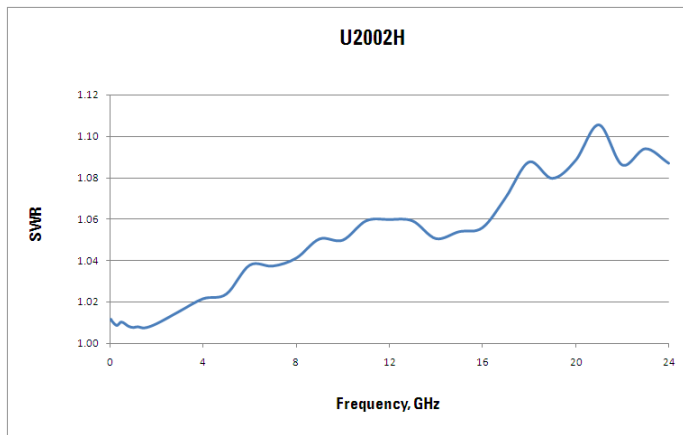

Figure 3-7 U2002H Typical SWR (25 °C ±10 °C)

3 Specifications and Characteristics

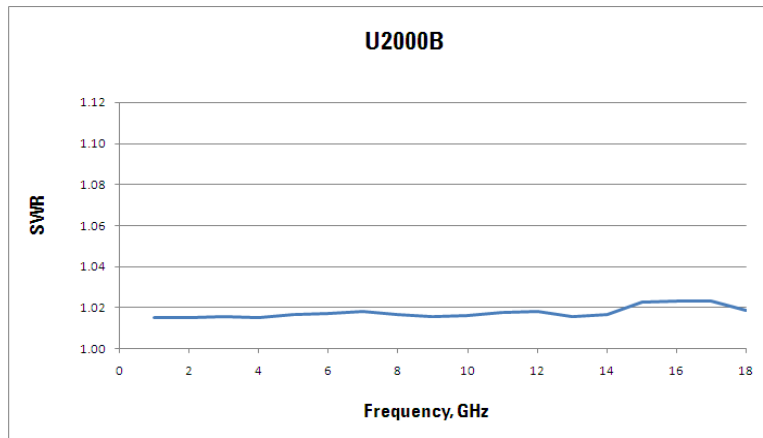

Figure 3-8 U2000B Typical SWR (25 °C ±10 °C)

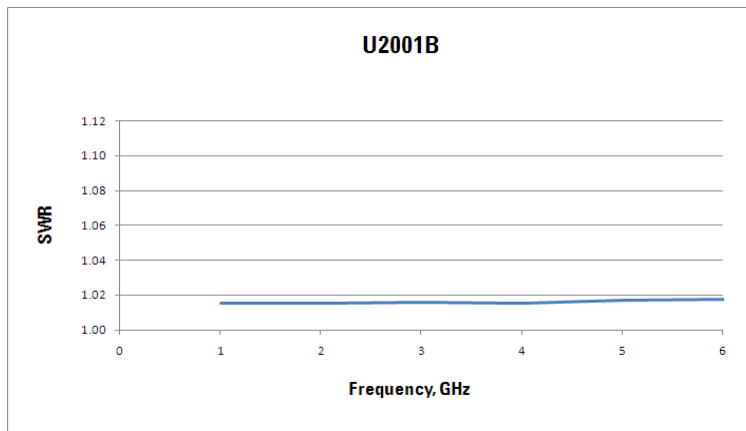

Figure 3-9 U2001B Typical SWR (25 °C ±10 °C)

Maximum SWR (0 °C to 55 °C)

Model	Frequency	SWR
U2000A	10 MHz to 30 MHz	1.21
	30 MHz to 2 GHz	1.15
	2 GHz to 14 GHz	1.20
	14 GHz to 16 GHz	1.23
	16 GHz to 18 GHz	1.27
U2001A	10 MHz to 30 MHz	1.21
	30 MHz to 2 GHz	1.15
	2 GHz to 6 GHz	1.20
U2002A	50 MHz to 2 GHz	1.15
	2 GHz to 14 GHz	1.20
	14 GHz to 16 GHz	1.23
	16 GHz to 18 GHz	1.27
	18 GHz to 24 GHz	1.30
U2004A	9 kHz to 2 GHz	1.15
	2 GHz to 6 GHz	1.20
U2000B	10 MHz to 2 GHz	1.14
	2 GHz to 12.4 GHz	1.18
	12.4 GHz to 18 GHz	1.25
U2001B	10 MHz to 2 GHz	1.14
	2 GHz to 6 GHz	1.18

3 Specifications and Characteristics

U2000H	10 MHz to 8 GHz	1.17
	8 GHz to 12.4 GHz	1.26
	12.4 GHz to 18 GHz	1.29
U2001H	10 MHz to 6 GHz	1.17
U2002H	50 MHz to 8 GHz	1.17
	8 GHz to 12.4 GHz	1.26
	12.4 GHz to 18 GHz	1.29
	18 GHz to 24 GHz	1.31

Maximum Power

Models	Maximum Power
U2000/1/2A	+25 dBm (320 mW) average, 20 VDC +33 dBm (2 W) peak, <10 μ s
U20004A	+25 dBm (320 mW) average, 5 VDC +33 dBm (2 W) peak, <10 μ s
U2000/1H	+33 dBm (2 W) average, 20 VDC +50 dBm (100 W) peak for 1 μ s
U2002H	+33 dBm (2 W) average, 10 VDC +50 dBm (100 W) peak for 1 μ s
U2000/1B	+45 dBm (30 W) average, 20 VDC +47 dBm (50 W) peak for 1 μ s

CAUTION

The U2004A USB power sensor is DC coupled. DC coupling of the input allows excellent low frequency coverage. However, the presence of external DC component signals may affect the accuracy of the power measurement. Users are advised to use suitable external DC block for the DC component removal.

DC voltages in excess of the maximum value (5 V) can damage the sensing diode.

Power Accuracy

This specification is valid only after zeroing and calibration of the power sensor at ambient environmental conditions.

Table 3-1 Average only Mode Power Accuracy¹ (with exclusions)

Model	Power Level	Accuracy 25 °C ±10 °C	Accuracy 0 °C to 55 °C
U2000/1/2/4A	-60 dBm to +20 dBm	±3.0%	±3.5%
U2000/1/2H	-50 dBm to +30 dBm	±4.0%	±5.0%
U2000/1B	-30 dBm to +44 dBm	±3.5%	±4.0%

Table 3-2 Normal Mode Power Accuracy^{1,2} (with exclusions)

Model	Power Level	Accuracy 25 °C ±10 °C
U2000/1/2A	-30 dBm to +20 dBm	±4.0%
U2000/1/2H	-20 dBm to +30 dBm	±5.0%
U2000/1B	0 dBm to +44 dBm	±4.5%

With conditions as follows:

- After zeroing³ and 30 minutes of power-on warm-up
 - Number of averages = 1024
- 1 The accuracy is essentially a combination of linearity, instrumentation accuracy, and traceability to absolute accuracy at 50 MHz, 0 dBm. Note: mismatch uncertainty, cal-factor uncertainty, and power level dependent terms (zero set, drift, and noise) are excluded in this specification and specified elsewhere in this guide.
 - 2 The accuracy for -7 dBm to +1 dBm (U2000/1/2A), +3 dBm to +11 dBm (U2000/1/2H), and +23 dBm to +31 dBm (U2000/1B) power level will be dominated by zero set and measurement noise. For overall accuracy, refer to the measurement uncertainty calculator which is available on the Agilent Technologies Web site.
 - 3 It is strongly advisable to perform external zeroing on the U2000 Series USB power sensor for power measurement level below -30 dBm for accurate measurements. During the external zeroing process, the RF input signal must be switched off or the device-under-test disconnected from the U2000 Series USB power sensor.

Power Accuracy Plots (Average only Mode)

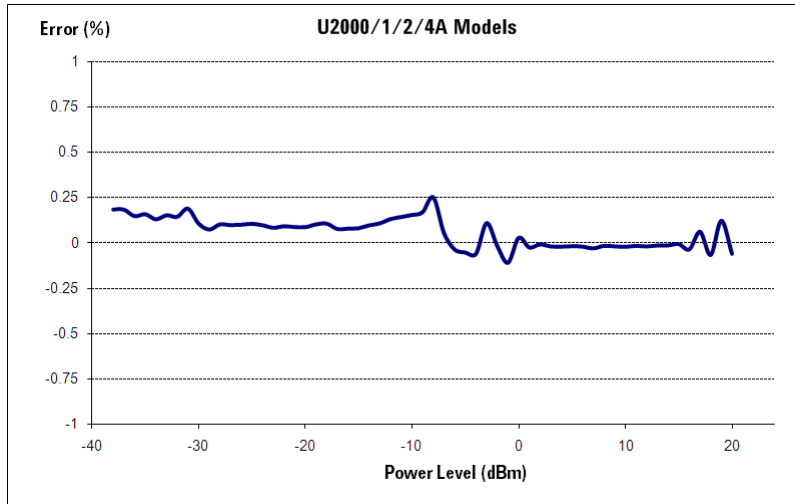

Figure 3-10 Typical power accuracy at 25 °C for U2000/1/2/4A models¹

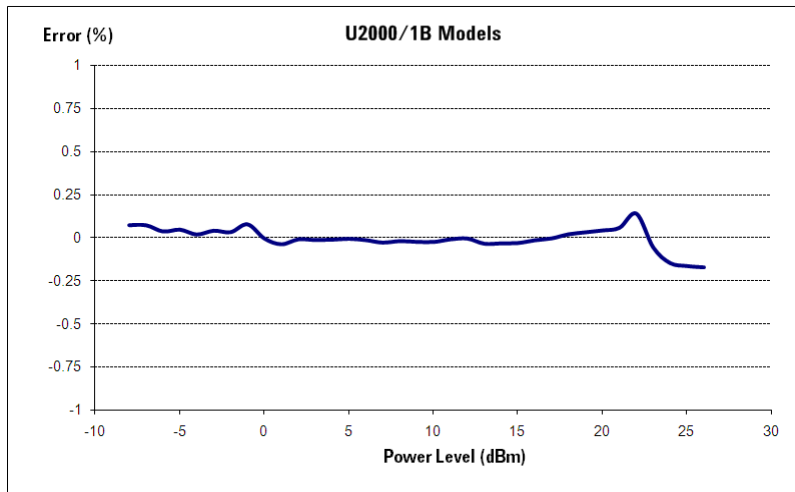

Figure 3-11 Typical power accuracy at 25 °C for U2000/1B models¹

3 Specifications and Characteristics

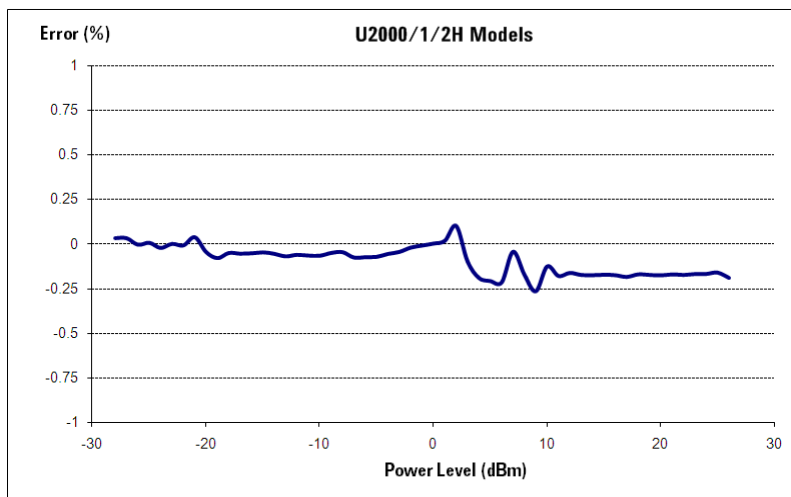

Figure 3-12 Typical power accuracy at 25 °C for U2000/1/2H models¹

¹ Measurement uncertainty $\leq 1.6\%$. At room temperature and excluding power level dependent terms (zero set, drift, and noise). Refer to *Agilent Fundamentals of RF and Microwave Power Measurements (Part 3) Power Measurement Uncertainty per International Guide* (Application Note 1449-3), 5988-9215EN for more information on measurement uncertainty.

Switching Point

The U2000 Series USB power sensors have two measurement paths: a low power path and a high power path as shown in [Table 3-3](#).

Table 3-3 Switching point

Sensor	Low Power Path	High Power Path	Switching Point
U2000A, U2001A, U2002A, U2004A	-60 dBm to -7 dBm	-7 dBm to +20 dBm	-7 dBm
U2000H, U2001H, U2002H	-50 dBm to +3 dBm	+3 dBm to +30 dBm	+3 dBm
U2000B, U2001B	-30 dBm to +23 dBm	+23 dBm to +44 dBm	+23 dBm

The power sensor automatically selects the proper power level path. To avoid unnecessary switching when the power level is close to the switching point, **Switching Point Hysteresis** is added.

	Error
Offset at Switch Point	$\leq \pm 0.5\%$ ($\leq \pm 0.02$ dB) typical
Switching Point Hysteresis	0.5 dBm typical

Examples

U2000/1/2/4A Power Sensors

The switching point for U2000/1/2/4A sensor is -7 dBm. The hysteresis causes the low power path to remain selected until approximately -6.5 dBm has been reached. As the power level increases above -6.5 dBm, the high power path will be selected. The high power path remains selected until approximately -7.5 dBm has been reached. As the power level decreases below -7.5 dBm, the low power path will be selected.

U2000/1/2H Power Sensors

The switching point for U2000/1/2H sensor is $+3$ dBm. The hysteresis causes the low power path to remain selected until approximately $+3.5$ dBm has been reached. As the power level increases above $+3.5$ dBm, the high power path will be selected. The high power path remains selected until approximately $+2.5$ dBm has been reached. As the power level decreases below $+2.5$ dBm, the low power path will be selected.

U2000/1B Power Sensors

The switching point for U2000/1B sensor is $+23$ dBm. The hysteresis causes the low power path to remain selected until approximately $+23.5$ dBm has been reached. As the power level increases above $+23.5$ dBm, the high power path will be selected. The high power path remains selected until approximately $+22.5$ dBm has been reached. As the power level decreases below $+22.5$ dBm, the low power path will be selected.

Zero Set, Zero Drift, and Measurement Noise

Average only Mode

For U2000/1/2A,

Range ¹	Zero Set (Internal)	Zero Set (External)	Zero Drift ²	Measurement Noise ³
-60 dBm to -35 dBm	±1.5 nW	±600 pW	200 pW	1 nW
-38 dBm to -15 dBm	±2 nW	±1.5 nW	400 pW	1.5 nW
-20 dBm to -9 dBm	±12 nW	±10 nW	1.5 nW	15 nW
-11 dBm to -5 dBm	±2 μW	±500 nW	50 nW	650 nW
-7 dBm to 15 dBm	±4 μW	±1 μW	500 nW	1 μW
10 dBm to 20 dBm	±6 μW	±5 μW	2 μW	10 μW

For U2004A,

Range ¹	Zero Set (Internal)	Zero Set (External)	Zero Drift ²	Measurement Noise ³
-60 dBm to -35 dBm	±2.8 nW	±600 pW	200 pW	1 nW
-38 dBm to -15 dBm	±3 nW	±1.5 nW	400 pW	1.5 nW
-20 dBm to -9 dBm	±12 nW	±10 nW	1.5 nW	15 nW
-11 dBm to -5 dBm	±2 μW	±500 nW	50 nW	650 nW
-7 dBm to 15 dBm	±4 μW	±1 μW	500 nW	1 μW
10 dBm to 20 dBm	±6 μW	±5 μW	2 μW	10 μW

For U2000/1/2H,

Range ¹	Zero Set (Internal)	Zero Set (External)	Zero Drift ²	Measurement Noise ³
-50 dBm to -25 dBm	±15 nW	±8 nW	2 nW	10 nW
-28 dBm to -5 dBm	±20 nW	±20 nW	4 nW	15 nW
-10 dBm to 1 dBm	±120 nW	±100 nW	15 nW	150 nW
-1 dBm to 5 dBm	±20 μW	±20 μW	500 nW	6.5 μW
3 dBm to 25 dBm	±40 μW	±30 μW	5 μW	10 μW
20 dBm to 30 dBm	±60 μW	±60 μW	20 μW	100 μW

3 Specifications and Characteristics

For U2000/1B,

Range ¹	Zero Set (Internal)	Zero Set (External)	Zero Drift ²	Measurement Noise ³
–30 dBm to –5 dBm	±1.8 μ W	±800 nW	200 nW	1 μ W
–8 dBm to 15 dBm	±2 μ W	±2 μ W	400 nW	1.5 μ W
10 dBm to 21 dBm	±12 μ W	±10 μ W	1.5 μ W	15 μ W
19 dBm to 25 dBm	±2 mW	±1 mW	50 nW	650 μ W
23 dBm to 44 dBm	±4 mW	±2 mW	500 μ W	1 mW

1 Condition: (i) 0 °C to 55 °C and (ii) 40 °C, 95% relative humidity.

2 Within one hour after zero set, at a constant temperature, after 24-hour warm-up of the power sensor.

3 The number of averages at 16 for **Normal** speed, measured over one minute interval and two standard deviations.

NOTE

The Zero Set, Zero Drift, and Measurement Noise specifications are only applicable to U2000 Series USB power sensors with serial prefix as shown below:

U2000A Serial prefix MY480/SG480 and above

U2001A Serial prefix MY481/SG481 and above

U2002A Serial prefix MY482/SG482 and above

U2004A Serial prefix MY484/SG484 and above

For power sensors with earlier prefixes, refer to [“Appendix A: Zero Set, Zero Drift, and Measurement Noise”](#) on page 82.

Effects of Averaging on Average only Mode Measurement Noise

Averaging over 1 to 1024 readings is available for reducing noise. The previous tables provide the measurement noise for a particular sensor. Use the noise multiplier in Table 3-4 for the appropriate speed (**Normal** or **x2**), and the number of averages to determine the total measurement noise value.

Table 3-4 Noise Multiplier for Average only Mode

Number of Averages	1	2	4	8	16	32	64	128	256	512	1,024
Noise Multiplier (s) (Normal Speed)	2.0	1.8	1.7	1.5	1.0	0.95	0.74	0.55	0.39	0.29	0.21
Noise Multiplier (s) (x2 Speed)	2.7	2.4	2.0	1.6	1.0	0.91	0.78	0.53	0.34	0.29	0.20

Example:

U2000A power sensor, -60 dBm to -35 dBm, number of averages = 4, normal speed.

Measurement noise calculation:

$$1 \text{ nW} \times 1.7 = 1.7 \text{ nW}$$

3 Specifications and Characteristics

Normal Mode

For U2000/1/2A,

Range ¹	Zero Set (Internal)	Zero Set (External)	Zero Drift ²	Measurement Noise ³	Noise Per Sample ⁴
-38 dBm to -15 dBm	47 nW	43 nW	25 nW	28 nW	90 nW
-20 dBm to -9 dBm	530 nW	480 nW	230 nW	300 nW	1 μW
-11 dBm to -5 dBm	30 μW	27 μW	19 μW	20 μW	55 μW
-7 dBm to 15 dBm	32 μW	30 μW	24 μW	21 μW	85 μW
10 dBm to 20 dBm	270 μW	200 μW	110 μW	180 μW	550 μW

For U2000/1/2H,

Range ¹	Zero Set (Internal)	Zero Set (External)	Zero Drift ²	Measurement Noise ³	Noise Per Sample ⁴
-28 dBm to -5 dBm	730 nW	500 nW	300 nW	310 nW	900 nW
-10 dBm to 1 dBm	5.3 μW	4.8 μW	3 μW	5 μW	10 μW
-1 dBm to 5 dBm	330 μW	270 μW	190 μW	230 μW	550 μW
3 dBm to 25 dBm	440 μW	300 μW	300 μW	260 μW	850 μW
20 dBm to 30 dBm	3.9 mW	2.8 mW	1.1 mW	2.8 mW	5.5 mW

For U2000/1B,

Range ¹	Zero Set (Internal)	Zero Set (External)	Zero Drift ²	Measurement Noise ³	Noise Per Sample ⁴
-8 dBm to 15 dBm	47 μW	43 μW	25 μW	28 μW	90 μW
10 dBm to 21 dBm	530 μW	480 μW	230 μW	300 μW	1 mW
19 dBm to 25 dBm	30 mW	27 mW	19 mW	20 mW	55 mW
23 dBm to 44 dBm	32 mW	34 mW	24 mW	21 mW	85 mW

- 1 Condition: (i) 0 °C to 55 °C and (ii) 40 °C, 95% relative humidity.
- 2 Within one hour after zero set, at a constant temperature, after 24-hour warm-up of the power sensor.
- 3 The number of averages at 1 for **Normal** speed, gate length of 2.27 ms, measured over one minute interval and two standard deviations.
- 4 The Noise Per Sample specification is only applicable for gated power working range stated in the “[Normal Mode Key Specifications and Characteristics](#)” on page 66.

Effect of Time-Gating and Averaging on Normal Mode Measurement Noise

The normal mode measurement noise will depend on the gate length (time-gated period in second) and the number of averages. The noise can be approximately calculated with the following equations.

If the gate length is <2.73 μs , use **Equation 1**:

$$\text{Noise} = \text{Noise per sample} \times \frac{1}{\sqrt{\text{Number of averages}}}$$

Otherwise, use **Equation 2**:

$$\text{Noise} = \text{Noise per sample} \times \frac{1}{\sqrt{\text{Number of averages}}} \times 4 \sqrt{\left(\frac{4}{\text{Gate length}/(0.68\mu s)} \right)}$$

NOTE

If the noise value obtained from Equation 1 or 2 is lower than the measurement noise specification, use the value as specified in the measurement noise table.

3 Specifications and Characteristics

Example:

U2000A power sensor, measured power = -4 dBm, gate length = 1.36 ms, number of averages = 256.

The measured power is -4 dBm, thus the corresponding noise per sample is 85 μ W (refer to the noise per sample table).

Use **Equation 2** for measurement noise calculation:

$$85\mu\text{W} \times \frac{1}{\sqrt{256}} \times 4 \sqrt{\left(\frac{4}{(1.36\text{ ms})/(0.68\mu\text{s})}\right)} = 1.123\mu\text{W}$$

The calculated measurement noise (*1.123 μ W*) is lower than the measurement noise specification (*21 μ W*). In this case, the measurement noise would be *21 μ W*.

Settling time

In **FAST** mode (using Free Run trigger), for a 10 dB decreasing power step, the settling time is:

	Time
U2000 Series USB Power Sensors	25 ms^1

1 When a power step crosses the auto-range switch point of the sensor, add 25 ms.

For **Normal** and **x2** speed, manual filter, and a 10 dB decreasing power step (not across the switching point), refer to [Table 3-5](#).

Table 3-5 Settling Time for **Normal** and **x2** Speed

Number of Averages	1	2	4	8	16	32	64	128	256	512	1,024
Settling Time (s) (Normal Speed)	<i>0.045</i>	<i>0.09</i>	<i>0.17</i>	<i>0.34</i>	<i>0.66</i>	<i>1.3</i>	<i>2.6</i>	<i>5.2</i>	<i>10.4</i>	<i>20.9</i>	<i>41.9</i>
Settling Time (s) (x2 Speed)	<i>0.042</i>	<i>0.05</i>	<i>0.09</i>	<i>0.17</i>	<i>0.34</i>	<i>0.66</i>	<i>1.3</i>	<i>2.6</i>	<i>5.2</i>	<i>10.4</i>	<i>20.9</i>

3 Specifications and Characteristics

For auto filter, default resolution, and a 10 dB decreasing power step (not across the switching point), refer to [Figure 3-13](#).

		Maximum sensor power within a range			
	X2 Speed	Normal Speed	U2000/1/2/4A	U2000/1/2H	U2000/1B
<i>Typical Settling Times</i>	45 ms	45 ms	+10 dBm	+20 dBm	+40 dBm
	82 ms	90 ms	+2 dBm	+12 dBm	+32 dBm
	1.3 s	2.6 s	-4 dBm	+6 dBm	+26 dBm
	1.5 s	2.7 s	-10 dBm	0 dBm	+20 dBm
	450 ms	460 ms	-20 dBm	-10 dBm	+10 dBm
	1.6 s	2.8 s	-30 dBm	-20 dBm	0 dBm
	20 s	39 s	-40 dBm	-30 dBm	-10 dBm
	24 s	42 s	-50 dBm	-40 dBm	-20 dBm
	24 s	42 s			
			Minimum sensor power within a range		

Sensor Dynamic Range

Figure 3-13 Settling time with auto filter, default resolution, and a 10 dB decreasing power step (not across the switching point)

Calibration Factor and Reflection Coefficient

The Calibration Factor (CF) corrects the frequency response of the sensor.

The Reflection Coefficient (Rho, or ρ) relates to the SWR based on the following formula:

$$SWR = \frac{1 + \rho}{1 - \rho}$$

Maximum uncertainties of the CF data are listed in the following tables. As the U2000 Series USB power sensors have two independent measurement paths (high and low power paths), there is only one set of CF data used for both high and low power paths for each sensor. The uncertainty analysis for the calibration of the sensors was done in accordance with the ISO Guide. The uncertainty data reported on the calibration certificate is the expanded uncertainty with a 95% confidence level and a coverage factor of two.

Cal Factor Uncertainty

Frequency	U2000A
	Maximum CF Uncertainty (25 °C ±10 °C)
10 MHz to 30 MHz	1.8%
30 MHz to 2 GHz	1.6%
2 GHz to 14 GHz	2.0%
14 GHz to 16 GHz	2.2%
16 GHz to 18 GHz	2.2%

Frequency	U2001A
	Maximum CF Uncertainty (25 °C ±10 °C)
10 MHz to 30 MHz	1.8%
30 MHz to 2 GHz	1.6%
2 GHz to 6 GHz	2.0%

Frequency	U2002A
	Maximum CF Uncertainty (25 °C ±10 °C)
50 MHz to 2 GHz	2.0%
2 GHz to 14 GHz	2.5%
14 GHz to 16 GHz	2.7%
16 GHz to 18 GHz	2.7%
18 GHz to 24 GHz	3.0%

Frequency	U2004A
	Maximum CF Uncertainty (25 °C ±10 °C)
9 kHz to 2 GHz	1.8%
2 GHz to 6 GHz	1.8%

Frequency	U2000B
	Maximum CF Uncertainty (25 °C ±10 °C)
10 MHz to 2 GHz	1.8%
2 GHz to 12.4 GHz	2.0%
12.4 GHz to 18 GHz	2.2%

Frequency	U2001B
	Maximum CF Uncertainty (25 °C ±10 °C)
10 MHz to 2 GHz	1.8%
2 GHz to 6 GHz	2.0%

Frequency	U2000H
	Maximum CF Uncertainty (25 °C ±10 °C)
10 MHz to 8 GHz	2.0%
8 GHz to 12.4 GHz	2.0%
12.4 GHz to 18 GHz	2.2%

3 Specifications and Characteristics

Frequency	U2001H
	Maximum CF Uncertainty (25 °C ±10 °C)
10 MHz to 6 GHz	2.0%

Frequency	U2002H
	Maximum CF Uncertainty (25 °C ±10 °C)
50 MHz to 8 GHz	2.5%
8 GHz to 12.4 GHz	2.5%
12.4 GHz to 18 GHz	2.7%
18 GHz to 24 GHz	3.0%

Trigger

Internal Trigger	
Resolution	<i>0.1 dB</i>
Level accuracy	± 1 dB
Jitter	± 1 μ s
External TTL Trigger Input	
Impedance	50 Ω or 1 k Ω
Trigger low	<1.1 V
Trigger high	>1.9 V
Minimum trigger pulse width	35 ns
Minimum trigger repetition period	80 ns
Trigger latency	11 μ s \pm 2 μ s
Trigger Delay	
Range	-0.15 s to +0.15 s
Resolution	1 μ s
Trigger hold-off	
Range	1 μ s to 400 ms
Resolution	1 μ s
Trigger Hysteresis	
Range	0 dB to +3 dB
Resolution	0.1 dB

Normal Mode Key Specifications and Characteristics

Parameters ¹	Performance
Maximum video bandwidth	40 kHz
Minimum rise time	40 μ s
Minimum fall time	40 μ s
Range settling time	150 μ s
Minimum pulse width	200 μ s
Sampling rate	1.47 Msps
Maximum capture length	150 ms
Maximum pulse repetition rate	150 kHz
Dynamic range	U2000/1/2A: -30 dBm to +20 dBm U2000/1/2H: -20 dBm to +30 dBm U2000/1B: 0 dBm to +44 dBm

1 Not applicable for U2004A

General Characteristics

Physical Characteristics

Net Weight	
U2000/1/4A	0.262 kg
U2002A	0.226 kg
U2000/1B	0.762 kg
U2000/1H	0.324 kg
U2002H	0.274 kg
Dimensions (L x W x H)	
U2000/1/4A	163.75 mm x 46.00 mm x 35.90 mm
U2002A	134.37 mm x 46.00 mm x 35.90 mm
U2000/1B	308.00 mm x 115.00 mm x 84.00 mm
U2000/1H	207.00 mm x 46.00 mm x 36.00 mm
U2002H	164.00 mm x 46.00 mm x 36.00 mm

Storage and Shipment

Environment	The sensor should be stored in a clean, dry environment
Temperature	-30 °C to +70 °C (non-operating)
Relative Humidity	Non-operating up to 90% at 65 °C (non-condensing)
Altitude	Non-operating up to 4,600 metres (15,000 feet)

USB Standard

USB Speed	Hi-Speed 2.0
------------------	--------------

3 Specifications and Characteristics

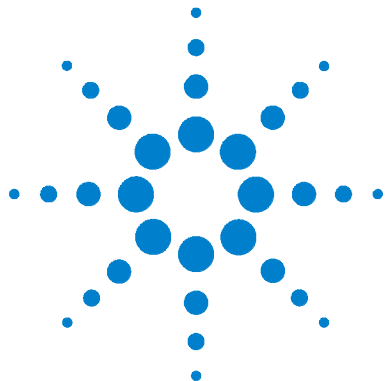

4 Service

General Information	70
Performance Test	71
Replaceable Parts	74
Service	76
Troubleshooting	76

This chapter describes the performance test and provides information on replaceable parts as well as on service details.



General Information

This chapter contains information about general maintenance, performance tests, troubleshooting and the repair of U2000 Series USB power sensors.

Cleaning

Use a clean, damp cloth to clean the body of the U2000 Series USB power sensors.

Connector Cleaning

CAUTION

The RF connector beads deteriorate when contacted with hydrocarbon compounds such as acetone, trichloroethylene, carbon tetrachloride, and benzene.

CAUTION

Clean the connector only at a static free workstation. Electrostatic discharge to the center pin of the connector will render the power sensor inoperative.

Keeping in mind its flammable nature, a solution of pure isopropyl or ethyl alcohol can be used to clean the connector.

Clean the connector face using a cotton swab dipped in isopropyl alcohol. If the swab is too big use, use a round wooden toothpick wrapped in a lint-free cotton cloth dipped in isopropyl alcohol.

Refer to *Agilent Application Note 326, Principles of Microwave Connector Care (5954-1566)* for proper cleaning methods.

Performance Test

Standing Wave Ratio (SWR) and Reflection Coefficient (Rho) Performance Test

This section does not establish preset SWR test procedures since there are several test methods and different equipment available for testing the SWR or reflection coefficient. Therefore, the actual accuracy of the test equipment must be accounted for when measuring against instrument specifications to determine a pass or fail condition. The test system used must not exceed the system Rho uncertainties shown in the following tables when testing the U2000 Series USB power sensors.

Table 4-1 Power Sensor SWR and Reflection Coefficient for the U2000A

Frequency	Actual Measurement	Maximum Rho	SWR
10 MHz to 30 MHz		0.070	1.15
30 MHz to 2 GHz		0.061	1.13
2 GHz to 14 GHz		0.087	1.19
14 GHz to 16 GHz		0.099	1.22
16 GHz to 18 GHz		0.115	1.26

Table 4-2 Power Sensor SWR and Reflection Coefficient for the U2001A

Frequency	Actual Measurement	Maximum Rho	SWR
10 MHz to 30 MHz		0.070	1.15
30 MHz to 2 GHz		0.061	1.13
2 GHz to 6 GHz		0.087	1.19

Table 4-3 Power Sensor SWR and Reflection Coefficient for the U2002A

Frequency	Actual Measurement	Maximum Rho	SWR
50 MHz to 2 GHz		0.061	1.13
2 GHz to 14 GHz		0.087	1.19
14 GHz to 16 GHz		0.099	1.22
16 GHz to 18 GHz		0.115	1.26
18 GHz to 24 GHz		0.130	1.30

CAUTION

DC voltages in excess of the maximum value (5 VDC) can damage the sensing diode.

Table 4-4 Power Sensor SWR and Reflection Coefficient for the U2004A

Frequency	Actual Measurement	Maximum Rho	SWR
9 kHz to 2 GHz		0.061	1.13
2 GHz to 6 GHz		0.087	1.19

Table 4-5 Power Sensor SWR and Reflection Coefficient for the U2000H

Frequency	Actual Measurement	Maximum Rho	SWR
10 MHz to 8 GHz		0.070	1.15
8 GHz to 12.4 GHz		0.111	1.25
12.4 GHz to 18 GHz		0.123	1.28

Table 4-6 Power Sensor SWR and Reflection Coefficient for the U2001H

Frequency	Actual Measurement	Maximum Rho	SWR
10 MHz to 6 GHz		0.070	1.15

Table 4-7 Power Sensor SWR and Reflection Coefficient for the U2002H

Frequency	Actual Measurement	Maximum Rho	SWR
50 MHz to 8 GHz		0.070	1.15
8 GHz to 12.4 GHz		0.111	1.25
12.4 GHz to 18 GHz		0.123	1.28
18 GHz to 24 GHz		0.130	1.30

Table 4-8 Power Sensor SWR and Reflection Coefficient for the U2000B

Frequency	Actual Measurement	Maximum Rho	SWR
10 MHz to 2 GHz		0.057	1.12
2 GHz to 12.4 GHz		0.078	1.17
12.4 GHz to 18 GHz		0.107	1.24

Table 4-9 Power Sensor SWR and Reflection Coefficient for the U2001B

Frequency	Actual Measurement	Maximum Rho	SWR
10 MHz to 2 GHz		0.057	1.12
2 GHz to 6 GHz		0.078	1.17

Replaceable Parts

Table 4-10 contains a list of replaceable parts. To order a part, quote the Agilent part number, specify the quantity required, and address the order to the nearest Agilent office.

NOTE

Within the USA, it is better to order directly from the Agilent Parts Center in Roseville, California. Ask your nearest Agilent office for information and forms for the “Direct Mail Order System.” Also your nearest Agilent office can supply toll free telephone numbers for ordering parts and supplies.

Table 4-10 Replaceable Parts

Model	Agilent Part Number	Qty	Description
U2000A	U2000-60006	1	U2000A replacement module
	5190-0062	1	Top label for U2000A
U2001A	U2001-60006	1	U2001A replacement module
	5190-0650	1	Top label for U2001A
U2002A	U2002-60006	1	U2002A replacement module
	5190-0651	1	Top label for U2002A
U2004A	U2004-60006	1	U2004A replacement module
	5190-0652	1	Top label for U2004A
U2000B	U2000-60007	1	U2000B replacement module
	5190-1710	1	Top label for U2000B
U2001B	U2000-60009	1	U2001B replacement module
	5190-1708	1	Top label for U2001B
U2000H	U2000-60008	1	U2000H replacement module
	5190-1709	1	Top label for U2000H
U2001H	U2000-60010	1	U2001H replacement module
	5190-1711	1	Top label for U2001H
U2002H	U2000-60011	1	U2002H replacement module
	5190-1712	1	Top label for U2002H
All models	5190-0061	2	Middle label
	5190-0060	1	Bottom label
	U2000-20001	1	Top cover
	U2000-20003	1	Bottom cover

Service

The following service instructions consist of information on troubleshooting, and repairs.

Troubleshooting

The U2000 Series USB power sensors represent a combination of a power meter and power sensor in one unit. If the LED is red and blinking, it indicates that there is a hardware error or operating system (OS) error in the power sensor. The LED will only be blinking red if the power sensor failed in the self-test. The command `SYSTEM:ERROR` is used to read the exact error messages which occur on the power sensor. Please kindly send the power sensor back to the nearest service centre for repair. Refer to the [“LED Indicator Guide”](#) for more information.

CAUTION

Electrostatic discharge will render the power sensor inoperative. Do not, under any circumstances, open the power sensor unless you and the power sensor are in a static free environment.

Repairing a Defective Sensor

There are no serviceable parts inside the U2000 Series USB power sensors. If the sensor is defective, please send it back to the nearest Agilent Service Center for repair. The entire module of the defective sensor will be replaced with the appropriate replacement module. See [Table 4-10](#).

Disassembly and Reassembly Procedure

Disassembly Procedure

Disassemble the power sensor by performing the following steps:

CAUTION

Disassemble the power sensor only in a static free workstation. Electrostatic discharge renders the power sensor inoperative.

Table 4-11 Disassembly Procedure

1 Remove the top label.



2 Loosen three screws by using M2 to remove the housing.



3 Replace the defective sensor module with a new sensor module. Please refer to [Table 4-10](#).



Reassembly Procedure

Tools required for reassembly:

Tools	Purpose	Qty	Torque value
M2 Torx	To fit the housing	1	3.98 lbs.in

Reassembly instructions:

The reassembly procedures are simply the reversal of the disassembly procedure.

Attenuator Disassembly and Reassembly Procedure for U2000B and U2001B

Disassembly Procedure

Tools required for disassembly:

Tools	Purpose	Torque value
¾" torque wrench	To loosen the attenuator	80 lbs.in
½" wrench	To prevent rotation	N/A

NOTE

The attenuator for U2000B and U2001B must not be disassembled under any circumstances except during annual calibration. Removing the attenuator for U2000B and U2001B will void the calibration.

Table 4-12 Attenuator Disassembly Procedure



- 1 Loosen the connector using the torque wrench.
- 2 After that clean the connector's threads with IPA. Ensure that the crystallized loctite is cleaned properly.

Reassembly Procedure

Tools required for reassembly:

Tools	Purpose	Torque value
Loctite Threadlocker 242	To secure the connection between the attenuator and the sensor's connector	N/A
3/4" torque wrench	To tighten the attenuator	12 lbs.in

Table 4-13 Attenuator Reassembly Procedure



- 1 Apply one drop of loctite on the first, second, and third threads of the connector.



- 2 Tighten the connector using the torque wrench.

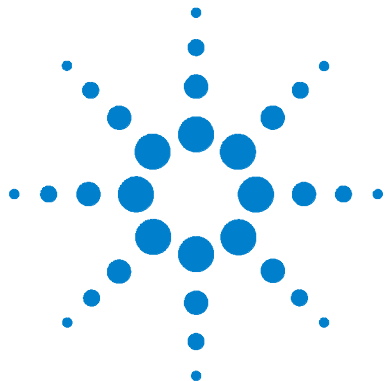

Appendix

Appendix A: Zero Set, Zero Drift, and Measurement Noise 82



Appendix A: Zero Set, Zero Drift, and Measurement Noise

The following specifications in [Table 5-1](#) are only applicable to the U2000 Series USB power sensors with the serial prefix as shown below:

Model	Serial Prefix
U2000A	Serial Prefix MY470/SG470 and below
U2001A	Serial Prefix MY471/SG471 and below
U2002A	Serial Prefix MY472/SG472 and below
U2004A	Serial Prefix MY474/SG474 and below

Table 5-1 Zero Set, Zero Drift, and Measurement Noise for Average only Mode

Range ¹	Zero Set	Zero Drift ²	Measurement Noise ³
-60 dBm to -35 dBm	±651 pW	996 pW	1.91 nW
-38 dBm to -15 dBm	±1.13 nW	400 pW	2.24 nW
-20 dBm to -9 dBm	±12.8 nW	6.01 nW	40.8 nW
-11 dBm to -5 dBm	±445 nW	155 nW	1.63 μW
-7 dBm to 15 dBm	±4.26 μW	3.20 μW	861 nW
10 dBm to 20 dBm	±6.84 μW	3.39 μW	19.5 μW

1 Condition: (i) 0 °C to 55 °C and (ii) 40 °C, 95% relative humidity.

2 Within one hour after zero set, at a constant temperature, after 24-hour warm-up of the power sensor.

3 The number of averages at 16 for **Normal** speed, measured over one minute interval and two standard deviations.

www.agilent.com

Contact us

To obtain service, warranty or technical support assistance, contact us at the following phone numbers:

United States:

(tel) 800 829 4444 (fax) 800 829 4433

Canada:

(tel) 877 894 4414 (fax) 800 746 4866

China:

(tel) 800 810 0189 (fax) 800 820 2816

Europe:

(tel) 31 20 547 2111

Japan:

(tel) (81) 426 56 7832 (fax) (81) 426 56 7840

Korea:

(tel) (080) 769 0800 (fax) (080) 769 0900

Latin America:

(tel) (305) 269 7500

Taiwan:

(tel) 0800 047 866 (fax) 0800 286 331

Other Asia Pacific Countries:

(tel) (65) 6375 8100 (fax) (65) 6755 0042

Or visit Agilent worldwide web at:

www.agilent.com/find/assist

Product specifications and descriptions in this document subject to change without notice. Always refer to Agilent web site for the latest revision.

© Agilent Technologies, Inc. 2007-2010

Printed in Malaysia

Fifth Edition, April 29, 2010

U2000-90405



Agilent Technologies